



**ELETTROQUADRI**  
*move the excellence*

**USER, MAINTENANCE AND  
INSTALLATION MANUAL**

**MICROPROCESSOR SYSTEM**

**MP2 - NR/ND**

**WITH SOFTWARE VERSION 80.01**



**TRANSLATION OF THE ORIGINAL INSTRUCTIONS**

ENGLISH

2024 Rev. 1.0

REVISION INDEX	REASON FOR REVISION	DATE OF REVISION
0.0	New edition	22/07/2024
1.0	Text editing/new logo	28/10/2024



**CONTENTS**

- 0 CONTENTS .....3**
- 1 GENERAL INFORMATION.....5**
  - 1.1. Installation Manual.....5
    - 1.1.1. Reproduction limits and copyright .....5
    - 1.1.2. Updates .....5
    - 1.1.3. Care of the instructions.....5
    - 1.1.4. How to print the Instruction Manual .....5
  - 1.2. How to use this manual.....6
    - 1.2.1. Page layout.....6
    - 1.2.2. Symbols .....7
    - 1.2.3. General definitions.....7
  - 1.3. Manufacturer's data .....8
  - 1.4. After-sales assistance .....8
  - 1.5. Warranty .....8
  - 1.6. Testing .....8
- 2 SAFETY .....9**
  - 2.1. Reference standards applied.....9
  - 2.2. Safety warnings .....9
    - 2.2.1. General warnings .....9
    - 2.2.2. Warnings for Installer safety .....9
  - 2.3. Identification of operating personnel.....10
    - 2.3.1. Personal Protective Equipment .....11
  - 2.4. Correct use .....11
  - 2.5. Incorrect use.....11
  - 2.6. Residual risks .....11
- 3 INSTALLATION.....13**
  - 3.1. First connection (tensioning the installation).....13
  - 3.2. COMMISSIONING PROCEDURE .....13
    - 3.2.1. INSTALLATION CONTROL PANEL CONNECTIONS .....14
  - 3.3. Inspection control .....14
    - 3.3.1. INSPECTION CONTROL WITH BILM3/BILM4 SWITCH .....14
    - 3.3.2. INSPECTION CONTROL WITH BILM5 SWITCH (with paramater Nc = YES) .....15
    - 3.3.3. INSPECTION CONTROL - SERIAL SYSTEM (WITH XCAB CAR ROOF BOARD). .....15
    - 3.3.4. INSPECTION CONTROL - SERIAL SYSTEM (WITH X-CAB CAR ROOF AND MP8120 PIT BOARD)...15
  - 3.4. Reset conditions .....16
- 4 PROGRAMMING .....17**
  - 4.1. General warnings .....17
  - 4.2. Programming the board .....17
    - 4.2.1. APP QuickUP .....18
    - 4.2.2. Board display.....18
  - 4.3. MP2 board programming using buttons on the board.....20
  - 4.4. Further board functions .....32
    - 4.4.1. LE SELECTION - Fault log reading.....32
    - 4.4.2. Fo selection - Omnibus procedure .....32
    - 4.4.3. EC SELECTION - Travel limit test.....32
    - 4.4.4. In selection - Uncontrolled movement test.....32
    - 4.4.5. PA selection - Commissioning.....32



<b>5</b>	<b>DIAGNOSTICS .....</b>	<b>33</b>
5.1.	General warnings .....	33
5.2.	Fault table and fault finding .....	33
<b>6</b>	<b>BOARD FUNCTIONS AND LAYOUT .....</b>	<b>43</b>
6.1.	General warnings .....	43
6.2.	Insulation test.....	43
6.3.	Switch functions .....	43
6.3.1.	UM/DM reed .....	43
6.3.2.	RZA / RZB reed switch contacts.....	43
6.3.3.	DMS / DMD reed switch contacts .....	44
6.3.4.	Slowdown / phase plug control at the top and lowest floors (CRSB/CRDB) .....	44
6.4.	Board technical specifications .....	44
6.4.1.	MP2 BOARD .....	44
6.4.2.	EXP expansion boards .....	44
6.4.3.	P2C minirelay position boards (with decimal output - one row per floor).....	45
6.4.4.	PUC mini-relay position boards (for coded display) .....	45
6.4.5.	ACF board.....	45
6.4.6.	DUPLO connection board (only with separate “arriving” indications for the two cabinets) .....	45
6.4.7.	TPX connection diagram.....	46
6.4.8.	MPX_CAN Board.....	46
6.4.9.	X-CAB Board .....	46
6.4.10.	X-DOOR board .....	48
6.4.11.	MP8120 board.....	49
6.5.	MP2-NR/ND board layout .....	49
6.5.1.	LEDs on MP2-NR/ND board.....	50
6.6.	Manoeuvres .....	51
6.6.1.	Single call manoeuvre or collective down manoeuvre.....	51
6.6.2.	Collective up/down manoeuvre .....	52
6.7.	Connections for Duplo/Duplex/Triplex/Quadruplex manoeuvres .....	52



# 1 GENERAL INFORMATION

## 1.1. INSTALLATION MANUAL

The Installation manual is an integral part of the board and must be kept with care and accompany the board throughout its entire life cycle, right up to final scrapping.

The manual has been drawn up by the Manufacturer to provide all the necessary information to those authorized to interact with the machine during its expected service life: buyers, installers, expert operators and specialized technicians.

**ELETTROQUADRI S.r.l.** declines all liability for improper use of the board and for damages caused as a result of operations not considered in this manual or in any case unreasonable.

### 1.1.1. REPRODUCTION LIMITS AND COPYRIGHT

Reproduction of the manual, even partial, and distribution by any means, unless expressly authorized by the Manufacturer, is prohibited.

Any unauthorized reproduction will be prosecuted in the manner and times prescribed by the laws in force.

© ALL RIGHTS RESERVED: copyright on this manual belongs to **ELETTROQUADRI S.r.l.** Reprinting, reproduction and translation, even partial, are prohibited without the written authorization of **ELETTROQUADRI S.r.l.**

The manual cannot be transferred to third parties for viewing without the written authorization of **ELETTROQUADRI S.r.l.**

### 1.1.2. UPDATES

Illustrations of the board are provide for explanatory purposes only and are not binding for the Manufacturer. The manufacturer reserves the right to make any changes to components, parts and/or supplies for the purpose of making improvements or for any other reason, without having to update this manual unless said changes alter machine operation and/or safety.



#### **IMPORTANT**

*The Manufacturer reserves the right to make changes without prior notice.*



#### **IMPORTANT**

*Any additions to the manual which the manufacturer deems appropriate to send to users must be kept together with the manual, becoming an integral part thereof.*

### 1.1.3. CARE OF THE INSTRUCTIONS

The Installation manual must be kept by a person responsible for said task, in a suitable place, so that it is always available for consultation in optimum condition.

It must always be easy to find and consulted by the skilled operators and must always accompany the board in the case of transfer or resale.



#### **CAUTION**

*The manual must be kept with care and replaced if it deteriorates and/or becomes illegible.*

### 1.1.4. HOW TO PRINT THE INSTRUCTION MANUAL



#### **CAUTION**

*ELETTROQUADRI S.r.l. shall not be held liable for any misinterpretation of the information contained herein if printing has not been executed correctly.*



## 1.2. HOW TO USE THIS MANUAL

The encharged operators must, under their own responsibility, read this manual carefully before using and programming the board.



### IMPORTANT

Keep this manual for the board's whole life cycle in a known and easily accessible place, so that it is always available when needed.

### 1.2.1. PAGE LAYOUT

The logic applied to the page layout of these instructions is presented and described below.



### Key:

- A. MANUAL HEADING
- B. FOOTNOTES
- 1. Manufacturer's logo
- 2. Board model
- 3. CHAPTER of the Installation Manual section - NUMBER and NAME
- 4. Type of manual
- 5. Board model and manual revision index
- 6. Number corresponding to the current page and total number of pages in the whole manual
- 7. Manufacturer's name and copyright



1. Title	Chapter Title. (1. "Chapter number")
1.1. Title	Heading. (1. "Chap. No." 1. "Heading Number")
1.1.1. Title	Sub-heading. (1. "Chap No." 1. "Heading no." (1. "Sub-heading number")
1. list	Numbered list, for identifying operations in succession.
• list	Bullet points, for general lists.

The references inside the figures may consist of letters (A, B, C ...) or sequential numbers (1, 2, 3 ...). Each figure with a reference may be followed by a **Key** describing the indicated elements.

### 1.2.2. SYMBOLS

For the purpose of highlighting important parts of the text or important specifications, certain symbols have been adopted, the meaning of which is described below.



#### **GENERIC HAZARD**

*Indicates situations of potential danger that, if overlooked, can seriously endanger people's health and safety.*



#### **GENERAL OBLIGATION**

*Indicates information or a precaution that must be observed to avoid operations that may damage the board, or in any case, a part of the text that deserves specific attention.*



#### **IMPORTANT**

*Indicates technical information of particular importance which should not to be overlooked.*



#### **ENVIRONMENTAL NOTE**

*Indicates the obligation to dispose of waste materials in an ecological manner.*



#### **ELECTROCUTION HAZARD**

*Indicates situations of potential danger that can seriously endanger people's health and safety.*

### 1.2.3. GENERAL DEFINITIONS

Some recurring terms in the manual are described to ensure a more complete understanding of their meaning.

ELETTROQUADRI S.r.l., the manufacturer of the aforementioned board, will be referred to as the **Manufacturer**.

#### **Danger zone:**

any area inside and/or near the electric cabinet containing the board in which the presence of a person constitutes a risk for the health and safety of said person.

#### **Exposed person:**

any person who is completely or partially inside a danger zone.

#### **Installer:**

Skilled technician for board installing/programming.

#### **Maintenance personnel:**

Person responsible for servicing and repairing the board.



## 1.3. MANUFACTURER'S DATA

### ELETTROQUADRI S.r.l.

Via Puccini, 1  
21050 Bisuschio (VA) - Italy  
Tel. +39 0332 470049 - Fax. + 39 0332 474032  
www.elettroquadri.net

## 1.4. AFTER-SALES ASSISTANCE

For any assistance, contact the Manufacturer's Assistance Service.

**CAUTION**

*The Manufacturer declines all liability for accidents involving persons or things caused by a failure to observe the instructions and regulations provided in this manual or the non-observance of the safety and accident prevention regulations in force in the country of machine use.*

## 1.5. WARRANTY

The MP2-NR/ND board warranty is valid for 1 year.

**CAUTION**

*The Manufacturer declines all liability for accidents involving persons or things caused by a failure to observe the instructions and regulations provided in this manual or the non-observance of the safety and accident prevention regulations in force in the country of machine use.*

## 1.6. TESTING

The board was tested during the production phases on the manufacturer's premises.





# 2 SAFETY

## 2.1. REFERENCE STANDARDS APPLIED

REFERENCE	TITLE
EN 81-20:2020	Safety rules for the construction and installation of lifts - Lifts for transporting persons and property - Part 20: Lifts for persons and property accompanied by persons
EN 81-50:2020	Safety rules for the construction and installation of lifts - Checks and testing - Part 50: Rules for the design, calculation, checking and testing of lift components
UNI 10411-1:2021	Modifications to electric lifts not conforming with Directive 95/16/EC
UNI 10411-2:2021	Modifications to hydraulic lifts not conforming with Directive 95/16/EC
UNI 10411-3:2016	Modifications to electric lifts installed in conformity with Directive 95/16/EC and UNI EN 81-1
UNI 10411-4:2016	Modifications to hydraulic lifts installed in conformity with Directive 95/16/EC and UNI EN 81-2
UNI 10411-5:2017	Modifications to electric lifts installed in conformity with Directive 95/16/EC or Directive 2014/33/EU and not conforming with UNI EN 81-1
UNI 10411-6:2017	Modifications to hydraulic lifts installed in conformity with Directive 95/16/EC or Directive 2014/33/EU and not conforming with UNI EN 81-2

## 2.2. SAFETY WARNINGS

### 2.2.1. GENERAL WARNINGS

**CAUTION**

*Consequently, any intervention which alters board configuration shall automatically exonerate the manufacturer from all liability.*

Consequently, any use other than those indicated in this manual shall exonerate **ELETTROQUADRI S.r.l.** from all liability for any risks which may occur.

### 2.2.2. WARNINGS FOR INSTALLER SAFETY

Before commencing work, the Installer must be fully knowledgeable of board function, configuration, and technical operating characteristics.

**CAUTION**

*Any work to be performed on the board requires maximum caution from the Installer.*

**IMPORTANT**

*Works on the board must be performed in strict observance of operational competences. The Manufacturer declines all liability for any failure to observe said competences.*

**CAUTION**

*During operations the operator must wear all the necessary Personal Protective Equipment (PPE).*

**CAUTION**

*The Installer must NEVER perform operations or manoeuvres on his own initiative which are not within his sphere of competence and may jeopardize his own safety and that of others.*

## 2.3. IDENTIFICATION OF OPERATING PERSONNEL

Operating personnel are the operators employed to perform installation, programming and maintenance activities depending on specific skills and qualifications, who, in all cases:

- are fully familiar with the instructions provided in this document on which they have been specifically trained and instructed;
- have gained sufficient experience and knowledge in the specific field of work.

When one of the following symbols is found at the start of a page or alongside a specific part of the text in this document, it means the operations described are the exclusive competence of a specific operator. The symbol also indicates the level of qualification required for the specific operator in question.

**INSTALLER**

Person with specific and certified technical qualifications responsible for electrical work on the machine who can, in complete autonomy:



- perform maintenance, disassembly, assistance, replacement and reassembly operations on electrical parts and equipment;
- pinpoint failures/electrical damage and determine the cause;
- perform calibration operations;
- envisage hazards deriving from these operations.

**ELETTROQUADRI's QUALIFIED TECHNICIAN**

Expert technician employed by the manufacturer who is suitable and qualified to perform the same tasks as the Installer.





The Expert Technician is able to perform specific activities (e.g. mechanical, electrical and electronic) not covered by the user's sphere of competence and which therefore cannot be executed autonomously (e.g. supervision of installation, testing, adjustments, optimization, etc.).

The Manufacturer, if stipulated in the contract with the user, may in any case guarantee, if needed, expert technical intervention via the after-sales assistance service.



### 2.3.1. PERSONAL PROTECTIVE EQUIPMENT

PICTOGRAMS	DESCRIPTION
	SAFETY FOOTWEAR MUST BE WORN
	PROTECTIVE GLOVES MUST BE WORN
	PROTECTIVE CLOTHING MUST BE WORN

### 2.4. CORRECT USE

The MP2-NR/ND board may ONLY be used in ELETTRQUADRI S.r.l. electrical lift control cabinets.

### 2.5. INCORRECT USE

The board MUST NOT be used:

- for any uses other than those described in heading 2.4 "Correct use".

### 2.6. RESIDUAL RISKS

Even when the safety regulations and rules of board use are observed as indicated in this manual, the following residual risks need to be noted:



***Residual risk of electrocution***

*Risk of electrocution relating to all parts which remain live when the cabinet is opened.*

---

PAGE LEFT INTENTIONALLY BLANK

---



## 3 INSTALLATION

### 3.1. FIRST CONNECTION (TENSIONING THE INSTALLATION)

To move the platform inside the shaft, before the safety contacts are installed,

→ make the following connections:

- R, S, T, GND, (neutral).
- Hoist motor.
- Rope: brake.
- Variable speed drive: hook the shielded cable up between the cabinet and the hoist motor (optional: brake control contacts encoder).
- Hydraulic: solenoid valves.
- For the Commissioning Kit, refer to the wiring diagram for the system in question.



#### **IMPORTANT**

*For the numbers of the terminals, refer to the system's wiring diagram.*

### 3.2. COMMISSIONING PROCEDURE



**CAUTION: ALL SAFETY DEVICES, FLOOR AND CAR DOOR CONTACTS AND INSPECTION LIMITS ARE DISABLED!!!**

1. **With the power supply cut off**, insert the "PA" connector (red wires with jumpers) in the "PA" terminal block in the cabinet.
2. Important: **make sure no other jumpers are made!**
3. Connect the installation control panel (STOP/UP/DOWN) (not supplied) to the "PA" connector.
4. Connect the motor thermistors (see the cabinet wiring diagram).
5. Power the cabinet. The board will indicate "PA" (flashing).
6. It is now possible to move the system with extreme caution to proceed with installation of equipment and safety devices.
7. Once operations have been completed, remove the installation control panel and the "PA" connector.
8. After completing and checking the connections, set the switch on the cabinet to the "INSPECTION" position.
9. Reset the board to exit the "COMMISSIONING" mode ("INSPECTION" mode will be active from the cabinet).



### 3.2.1. INSTALLATION CONTROL PANEL CONNECTIONS

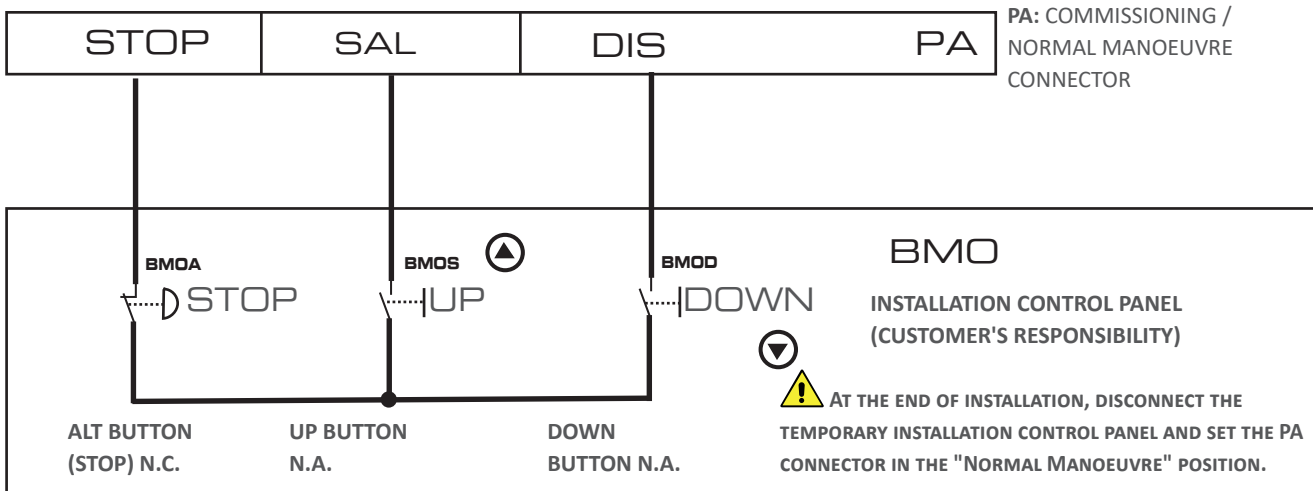

## 3.3. INSPECTION CONTROL

### 3.3.1. INSPECTION CONTROL WITH BILM3/BILM4 SWITCH

The **inspection control** is activated by setting the switch from "NOR" to "ISP" position. The **RM** mini-relay is energized and sends the information that inspection control has been activated to terminal **J11/6(RM)** of the board; "HH" signal will appear on board display.

**The contactors are controlled by the board** which actuates the control signals received from the inspection control panel:

- Inputs J7/1(▼) and J7/2(▲) receives the control signals from the "down" and "up" buttons (if both signals are present, no control signal is output).
- The "down" and "up" buttons, via their diodes, terminal 2A or BSQ/BQD and the RM contact, power the safety chain; the board checks for voltage at input J7/8 (led D3) and outputs the close doors signal.
- When full closure of the safety chain is confirmed via the pick-up point at input J7/10 (led D4), the slide and contactors are activated.
- Depending on the signals at inputs J7/1(▼) and J7/2(▲) the board activates the high speed+down outputs (GV+D) or high speed+up outputs (GV+S) and monitors their excitation and de-excitation as in normal operation.
- To prevent repeated jog operation in a single direction of travel and immediate reversal of direction, a delay of 1 second has been introduced between the release of a button and the response of the board to the next operation of the same or another direction button.
- The faults indication is also active during the inspection activity.
- The run of the car is limited by CRS and CRD mechanical switches or by bistable CRSB / CRDB switches at the top and bottom floors.
- Once the inspection is completed, the car, if it has been moved, resets to the lowest floor, or to its former destination.



### 3.3.2. INSPECTION CONTROL WITH BILM5 SWITCH (WITH PARAMATER Nc = YES)

The **inspection control** is activated by setting the switch from “NOR” to “ISP” position. The **RM** mini-relay is energized and sends the information that inspection control has been activated in response to the board inputs; the following appear on the board display.

HH = No control panel under inspection (if the chain confirms resetting in progress...)

H1 = Inspection from car top.

H2 = Inspection from cabinet

H3 = Inspection from cabinet + car top.

H4 = Inspection from pit

H5 = Inspection from car top + pit

H6 = Inspection from cabinet + pit

H7 = Inspection from pit + car top + cabinet

H FLASHING = pit control panel inspection activation memory: reset MP2 microprocessor board with RST key.

### 3.3.3. INSPECTION CONTROL - SERIAL SYSTEM (WITH XCAB CAR ROOF BOARD).

The **inspection control** is activated by setting the switch from “NOR” to “ISP” position. The **RM** mini-contactor is energized and sends the information that **inspection control** has been activated in response to the board inputs; the following appear on the board display:

HH = No control panel under inspection (if the safety chain confirms resetting in progress...)

H1 = Inspection from car top.

H2 = Inspection from cabinet

H3 = Inspection from cabinet + car top.

H4 = Inspection from pit

H5 = Inspection from car top + pit

H6 = Inspection from cabinet + pit

H7 = Inspection from pit + car top + cabinet

H FLASHING = pit control panel inspection activation memory: reset MP2 microprocessor board with RST key.

### 3.3.4. INSPECTION CONTROL - SERIAL SYSTEM (WITH X-CAB CAR ROOF AND MP8120 PIT BOARD).

The **inspection control** is activated by setting the switch on one of the maintenance control panels from "NOR" to "ISP". The **RM** mini-contactor is energized and sends the information that inspection control has been activated in response to the board inputs; the following appear on the board display:

HH = No control panel under inspection (if the safety chain confirms resetting in progress...)

H1 = Inspection from car top.

H2 = Inspection from cabinet

H3 = Inspection from car top + cabinet (only car roof panel active)

H4 = Inspection from pit

H5 = Inspection from car top + pit (both must give the same direction)

H3 = Inspection from pit + cabinet (only pit panel active)

H7 = Inspection from car top + pit + cabinet (they must give the same direction, cabinet not active)



**CAUTION:** When using the pit and/or opening of lowest floor lock control panel (with 81.20) the board maintains the “pit access memory” (the MP8120 board emits a sound for 3 seconds), the MP2 board displays a flashing H. To return to normal manoeuvre, perform manual reset:

- Using the board, press and hold the PRG button for 5 seconds; the MP8120 board will emit a two-tone signal to confirm that reset has been completed.

- Using the floor key, keep it in the active position and the MP8120 board will emit a two-tone signal to confirm that reset has been completed.



### 3.4. RESET CONDITIONS

In the shaft, the board loses knowledge of the car position under the following conditions:

- Loss of power.
- After inspection control (when the car has been moved).
- When reset button on the board is activated.
- After board programming sequence.
- After board programming sequence using the QuickUP APP.
- After faults where reset to the lowest floor is needed.

The reset sequence will always bring the car to lowest floor; different conditions are possible:

- Car already at the lowest floor (UM/DM LEDs on and CRD LED off): the reset happens without moving the car.
- Car slightly higher than the lowest floor (CRD LED off): the car moves down at low speed, and stops when it encounters both magnetic strips at the lowest floor level (UM DM LEDs on).
- Car in higher position in the shaft (CRD LED on): the car moves down at high speed, slows down when it encounters the bistable lower CRDB reset switch and stops when it encounters both magnetic strips at the lowest floor level (UM DM LEDs on).

**IMPORTANT**

*If the main floor is not the lowest floor, the reset described above will conclude with the car returning to the main floor.*

**IMPORTANT**

*The LED functions may vary depending on system configuration, see the table in “6.5.1. LED sulla scheda MP2” a pagina <?>.*





# 4 PROGRAMMING

## 4.1. GENERAL WARNINGS



INSTALLER



### CAUTION

*During operations the operator must wear all the necessary Personal Protective Equipment (PPE).*



### RESIDUAL RISK OF ELECTROCUTION

*Risk of electrocution relating to all parts which remain live when the cabinet is opened.*



### IMPORTANT

*The Manufacturer declines all liability for operations performed:*

- *by inadequate personnel;*
- *without observing the health and safety regulations in force;*
- *without observing the procedures provided in these instructions.*



### IMPORTANT

*Before performing any procedure make sure you have read and understood all the various steps, seen all the relative images and adopted the safety and protection measures described.*

## 4.2. PROGRAMMING THE BOARD

The MP2 board parameters can be configured using:

- the QuickUP APP (EQBLE tool needed).
- the PROGR and ENT/RST buttons on the board.

### 4.2.1. APP QUICKUP



Apple QR Code



Play QR Code

Connect your smartphone to the control cabinet using the EQBLE Tool.

In real time you can make calls, view system status, inputs, outputs and diagnostics on a user-friendly graphic interface. Extended fault description.

Configuration parameters can be consulted and edited in a descriptive and intuitive way. No longer any need to act on the buttons on the board!

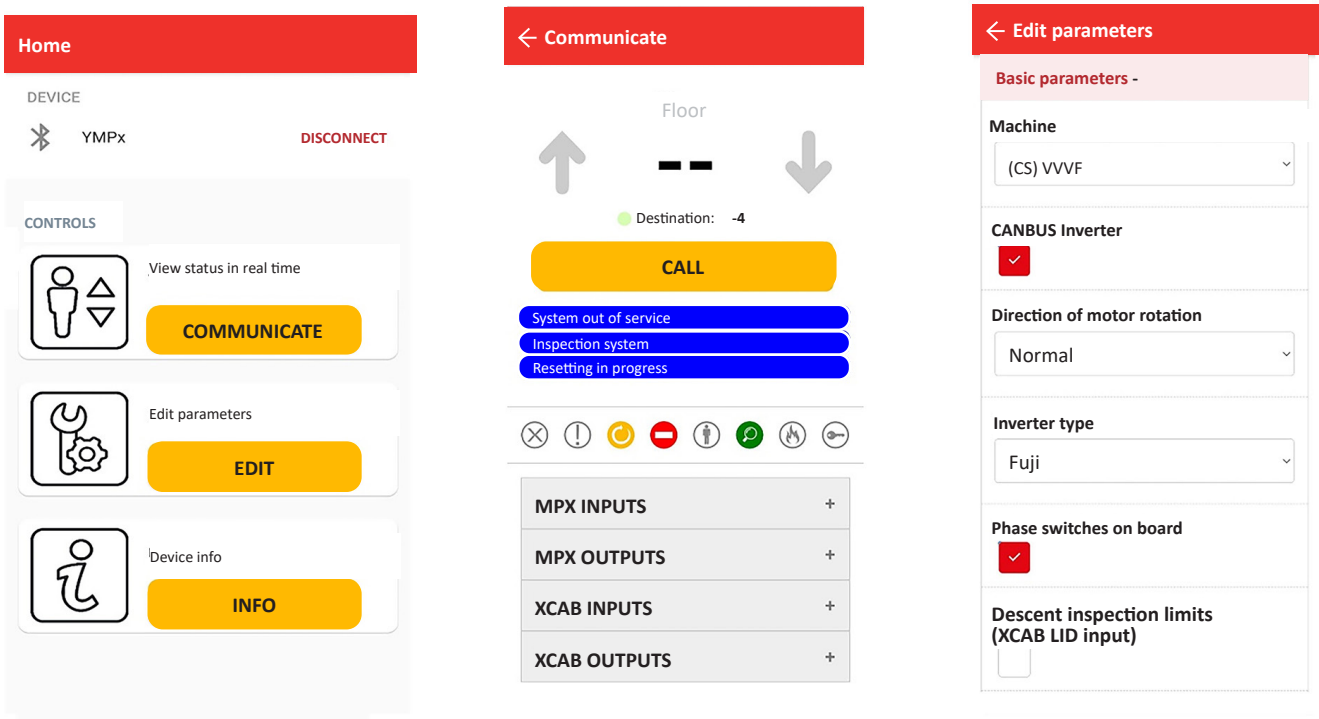

### 4.2.2. BOARD DISPLAY

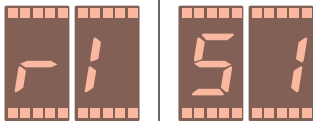
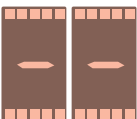
Indication on the display	Description
	Program release version (e.g. "r151"); displays on power up.
	System resetting.

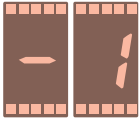
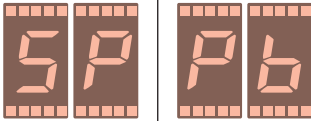
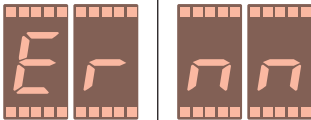
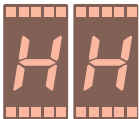
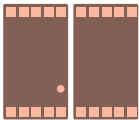
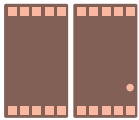
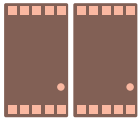
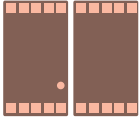
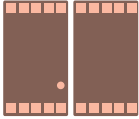
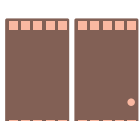
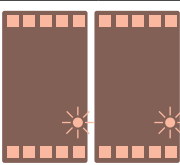

Indication on the display	Description
	Floor position indicator (e.g. "-1").
	Combination of letters and numbers for programming the board, timers and other variables and functions. See par. "4.3. Programmazione della scheda MP2 tramite tasti bordo scheda".
	Error message. See par. "5.2. Tabella errori e ricerca guasti".
	Inspection manoeuvre in progress.
	<b>Programming mode Pb → AC:</b> <ul style="list-style-type: none"> <li>front access only.</li> </ul>
	<b>Programming mode Pb → AC:</b> <ul style="list-style-type: none"> <li>rear access only.</li> </ul>
	<b>Programming mode Pb → AC:</b> <ul style="list-style-type: none"> <li>both accesses.</li> </ul>
	<b>Programming mode PS:</b> <ul style="list-style-type: none"> <li>duplo/duplex/triplex/quadruplex: floors not served.</li> </ul>
	<b>Normal operation, actuation:</b> <ul style="list-style-type: none"> <li>of a car call button.</li> <li>of a floor call button.</li> </ul>
	<b>Normal operation, actuation:</b> <ul style="list-style-type: none"> <li>of the door open button.</li> <li>of the photocells or mobile rib.</li> <li>of the overload.</li> <li>of machine room temperature.</li> </ul>
	<b>Normal operation:</b> <ul style="list-style-type: none"> <li>timer running.</li> </ul>



### 4.3. MP2 BOARD PROGRAMMING USING BUTTONS ON THE BOARD

Use the following keys to program the board: **PROGR**, **ENT/RST**.

The safety chain must be open to gain access:

**LED: D1-D2-D3-D4** off

Disconnect the call terminals before proceeding.

For example: **after opening the safety chain**, press and hold the **PROGR** button and after about 1 second tap the **ENT/RST** button 4 times: this opens the **MAIN MENU** (the displays shows  $5P$  and the program code alternately).



#### IMPORTANT

To quit the programming procedure at any time, simply close the safety chain.



#### IMPORTANT

Reset the board by holding the "RESET" button down for 5 sec.



#### IMPORTANT

The programmed data **MUST** be confirmed with **ENT/RST**.



PROGR

Press **PROGR** to change the program/move the dot/modify the parameter.



ENT/RST

Press **ENT/RST** to enter the selected program/confirm the setting.

Key/Terminal block	Function
M1A/1 + GND	increments numerical values.
M1B/1 + GND	decrements numerical values.

MAIN MENU			
Codes	Values	Meaning	Description



MAIN MENU					
SP		P <sub>b</sub>	Basic programming	Programming menu elements	
		P <sub>t</sub>	Time programming		
		P <sub>o</sub>	Option programming		
		P <sub>L</sub>	Light signal programming		
		LE	read fault log (see par. "4.4.1")		
		SS	special procedures		
		└─▶	F <sub>o</sub>		omnibus procedure (see par. "4.4.2")
			E <sub>c</sub>		travel limit test (see par. "4.4.3" )
			I <sub>n</sub>		Uncontrolled movement test (see par. "4.4.4" )
			P <sub>R</sub>		commissioning (see par. "4.4.5" )
	nu				
FP	Programming end				

**IMPORTANT**

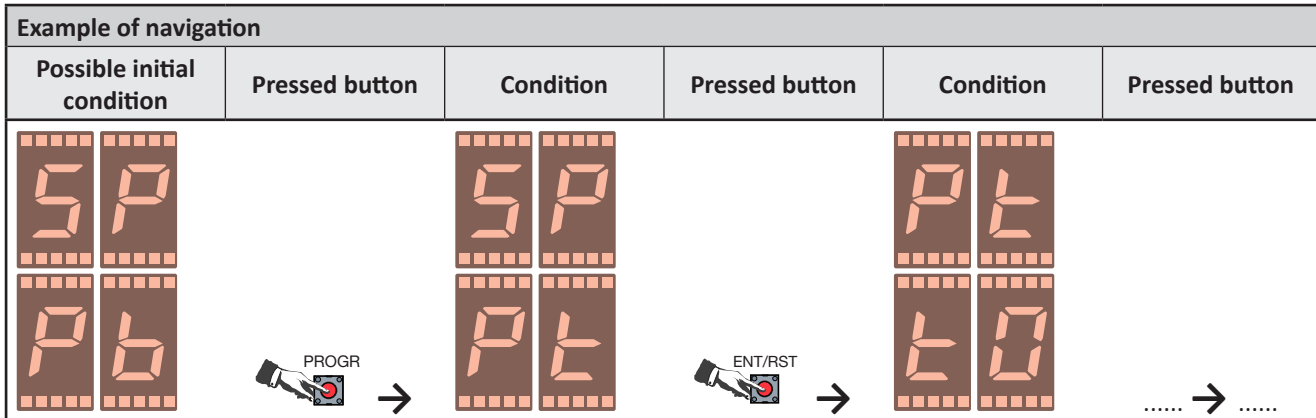

The display will show the code of the selected menu and the submenu code (if any) in alternation.

Example of navigation					
Possible initial condition	Pressed button	Condition	Pressed button	Condition	Pressed button
 SP Pb	 ENT/RST	 AL 1F	 ENT/RST	 LE LS	<p>The successive P<sub>b</sub> submenu will display</p>
	 PROGR	 AL 2F			<p>To go to the next function in the PL submenu:</p>



**IMPORTANT**

The following tables illustrate the complete programming structure, but some options may no longer display after certain functions have been set.



 			Basic programming
Codes	Values	Meaning	Description
RL	1F	rope 1 speed	type of actuation
	2F	rope 2 speed	
	1d	hydraulic	
	CF	variable frequency drive	
Fc	no	standard fire services management	
	YES	fire services management via MPX_CAN microprocessor board	
Ti	no	Fuji type variable speed drive	
	YES	Omron type variable speed drive	
rd	no	Current rotation	Motor rotation reverse (only with MPX_CAN)
	YES	Reverse rotation	
Cr	no	CRS/CRD not on board	
	YES	CRS/CRD on board	
Lb	no	Not active	if active: enables control via the board Micro-processor for bistable lowest floor inspection ramp down switch RIDB
	YES	Enabled	
Lh	no	Not active	if active: enables control via the board Micro-processor for bistable ramp down and top floor inspection switch) RISB
	YES	Enabled	



TC	CS	universal	<b>Type of manoeuvre</b>	
	Cd	collective down		
	CP	car: universal Floors: reserve in order of call		
	Sc	floors: universal Car: reserved		
	CC	car: reserve. Floors: collective complete		
CL	S	simplex	<b>type of installation</b>	
	SS	simplex with selective access		
	d	duplo/duplex/triplex/ quadruplex		
	dS	duplo/duplex/triplex/ quadruplex with selective access		
Rd	00	CAR A	<b>duplo/duplex/triplex/quadruplex: car setting</b>	
	01	CAR B		
	02	CAR C		
	03	CAR D		
UP	1 to 31		<b>last floor setting</b>	
PP	0 to UP		<b>main floor setting</b>	
RC	0 to UP		<b>accesses/opening side setting</b>	
	R.C	0.0		front, floor 0
	R.C.	00.		rear, floor 0
	R.C.	0.0.		front+rear, floor 0
P.F	0 to UP		<b>fire services floor setting</b>	
FS	0 to UP		<b>out of service parking floor (CFS)</b>	
PR	PP to UP	-- = PP	<b>duplo/duplex/triplex/quadruplex: alternative parking floor</b>	
PS	0 to UP		<b>duplo/duplex/triplex/quadruplex: floors not served (skip floors)</b>	
	P.S	front		
	PS.	rear		
	P.S.	front+rear		
SF	0 to UP		<b>STAFF manoeuvre: service staff floors setting</b>	
	S.F	front STAFF operation		
	S.F.	rear STAFF operation		
Pc	no	parking doors open	<b>parking doors</b>	
	YES	parking doors closed		
CP	0 to UP		<b>setting parking with doors closed/open on different floors</b>	
	C.P	front doors closed		
	CP.	rear doors closed		
	C.P.	front+rear doors closed		





IP	no	stops at the last served floor	return to main floor
	YES	returns to the main floor or duplex/triplex/quadruplex parks at a parking floor.	
PA	no	opens	block doors opening for testing
	YES	does not open	



 				Timer programming	
Code	range	unit of	default	meaning and use	
t0	20 to 90	sec	20.	high speed travel time in normal operation	
t1	2 to 60	sec	08.	floor time (time for which the doors remain open)	
t2	0 to 30	dsec	0.0	door open delay after retiring cam drops	
t3	1 to 90	sec	06. (x10)	simplex: return to main floor time	
t4	1 to 90	min	15	hydraulic: return to lowest floor time	
t5	8 to 60	sec	15.	maximum doors open/close movement time	
t6	0 to 30	dsec	0.0	open command hold time after open limit switch tripped	
t7	0 to 30	dsec	1.5	close command hold time after close limit switch tripped	
t8	20 to 90	dsec	4.0	occupied hold time after doors closed	
t9	0 to 99	dsec	0.0	hydraulic: star/delta switching delay	
tA	0 to 99	dsec	0.0	hydraulic: motor stop delay at floor	
tB	4 to 250	dsec	0.4	DRA/DRB signal wait delay	
tC	20 to 250	sec	10.	duplo/duplex/triplex/quadruplex: emergency car start time	
tD	5 to 99	sec	15.	duplo/duplex/triplex/quadruplex: start wait time for parking	
tE	50 to 250	sec	00.	duplo/duplex/triplex/quadruplex: closest call function activation time	
tF	0 to 250	sec	0.0	only if Elettroquadri has set "PICK-UP manoeuvre": main floor departure delay	
tH	0 to 50	dsec	0.0	contactor excitation delay after slide excitation	
tL	0 to 99	sec	70.	duplo/duplex/triplex/quadruplex: car out of service time	
tN	3 to 30	sec	20.	travel time at low speed	
tO	0 to 25	dm/sec	0.0	reset mode setting: if = 0.0 resetting with stop on phase plug and restart if = car speed (m/s) resetting without interrupted travel	
tP	10 to 99	dsec	4.0	J11/1 signal drop wait time (FSC)	
tR	0 to 10	dsec	0.0	up travel stop delay after DM magnetic track engaged	
tT	0 to 10	dsec	0.0	down travel stop delay after UM magnetic track engaged	







 				Timer programming	
Code	range	unit of	default	meaning and use	
tU	0 to 99	num	20	<b>duplo/duplex/triplex/quadruplex:</b> K = forgotten call coefficient K not = 0 (minimum 20 sec. delay) K= sec. wait X floors (not ground) divided by number of cars	
P0	2 to 50	dsec	0.3	<b>variable speed drive: contactor closure delay:</b> up/down/low speed when J11/1 signal not present (FSC)	
P1	0 to 120	sec	00	<b>variable speed drive: board initialisation delay on power on</b>	
P2	0 to 50	dsec	0.0	<b>call execution delay after swing door closure</b>	
P3	3 to 250	sec	20.	<b>timed car light off delay</b>	
P4	0 to 99	dsec	0.0	<b>retiring cam drop delay at stop</b>	
P5	5 to 60	dsec	3.0	<b>J11/1 signal wait time (FSC)</b>	
P6	0 to 80	dsec	2.0	<b>resetting delay without travel interruption</b> (T0 = resetting mode selection)	
P7	0 to 250	sec	00.	<b>A3 hydraulic: valve excitation time during lowest floor test</b> if = 0 the test does not run	
P8	0 to 80	dsec	0.0	<b>A3 hydraulic:</b>	
				2U = YES bt = 00	<b>excitation advance time for 2nd valve on start</b>
				2U = no bt = 01	<b>J12/3 present/absent (CF5, led CF5) for Moris EKMI valve control</b>
2U = no bt = 02	<b>2 J12/2 (CF4, led CF4) and J12/3 (CF5, led CF5) inputs present/absent together timer for GMV/NGV-A3 valve control</b>				
P9	0 to 80	dsec	0.0	<b>A3 hydraulic:</b>	
				2U = YES bt = 00	<b>de-excitation delay timer for 2nd valve on stop</b>
				2U = no bt = 02	<b>2 motor de-excitation delay timer when RUN signal drops (GMV/NGV-A3)</b>
Pa	0 to 50	dsec	0.0	<b>hydraulic: up releveling stop delay after DM reed</b>	
Pb	0 to 50	dsec	00	<b>hydraulic: down releveling stop delay after UM reed</b>	
Pc	0 to 50	dsec	0.0	<b>hydraulic: departure delay after releveling following call</b>	
Pd	0 to 50	dsec	1.0	<b>gong pulse duration</b>	
Pe	0 to 15	min	00	<b>photocell occlusion alarm delay</b> (0 = disabled)	
Pf	0 to 99	min	00	<b>time after which lockout due to excessive attempts to open/close the door is reset</b> (0 = disabled)	
Ph	0 to 50	dsec	0.0	<b>not used</b>	
Pl	20 to 90	sec	20.	<b>high speed travel time during reset</b>	
Pn	5 to 120	min	10	<b>energy saving activation time (ES=YES)</b>	
Po	10 to 90	sec	20	<b>variable speed drive: call disable time after energy saving activation</b> (equal to inverter shutdown time)	



 				Timer programming
Code	range	unit of	default	meaning and use
PP	0 to 60	sec	00	<b>STAFF manoeuvre: door open hold time at selected floor</b> (SF = enabled)
Pr	0 to 90	sec	00	<b>using the QuickUP WeLift app: call drop wait time</b>
U0*	0 to 50	sec	00	<b>travel ramp down delay timer with AUX active</b>
U1	0 to 20	sec. (with dot on) min. (with dot off)		<b>Normal manoeuvre actuation delay timer</b> <b>NOTE: ONLY WITH PARAMETER Et=0</b>
U2	0 to 20	sec. (with dot on) min. (with dot off)		<b>Emergency manoeuvre actuation by board delay timer</b>
U3	0 to 20	sec. (with dot on) min. (with dot off)		<b>Emergency manoeuvre by board maximum duration timer</b>



\* **IMPORTANT**A "." after the first digit indicates **SECONDS**.No "." after the first digit indicates **MINUTES**.

 			Option programming
Codes	Values	Meaning	Description
FC	no	disabled	<b>phase control</b>
	YES	active	
Rc	R.c	front	<b>self-retaining in door closure</b>
	R.c.	rear	
	R.c.	front+rear	
Ro	R.o	front	<b>self-retaining in door opening</b>
	R.o.	rear	
	R.o.	front+rear	
SE	no	disabled	<b>enable car serial connection</b>
	YES	active	
2P	no	disabled	<b>collective down manoeuvre: double button on main floor</b>
	YES	active	
SC	no	disabled	<b>cancel car calls</b>
	YES	active	
Rr	no	disabled (restart when button released)	<b>restart after car stopped with "Alt" button</b>
	YES	active (restart with car call)	
rE	no	disabled	<b>rope: restart after Er-23 (travel limit or fall arrestor)</b>
	YES	active	

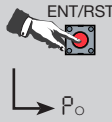

			Option programming
Codes	Values	Meaning	Description
rL	rL	excessive time taken to leave the floor	conditions enabling restart after travel timeout (max 2 consecutive attempts)
	rL.	low speed travel timeout (max 2 consecutive attempts)	
	rL.	"leave floor" or "low speed" or "high speed" travel timeout	
PH	no	disabled	enable door open/close control with car roof maintenance panel (the wiring diagram must be changed – contact Elettroquadri - )
	YES	active	
CC	no	disabled	hydraulic: second safety circuit check before out of service
	YES	active	
rP	no	disabled	hydraulic: second releveing attempt
	YES	active	
2u	no	disabled	A3 hydraulic: enable operation of 2nd down travel valve
	YES	active	
Cb	no	disabled: car call button actuation, closes the doors and resets floor time	floor time timeout (door closure)
	YES	enabled: doors close on car call disabled (to close: DCB or wait for floor time to time out)	
nF	no	disabled (the car parks at the set floors)	duplo/duplex/triplex/quadruplex operation: force parking at main floor
	YES	enabled (car returns to main floor)	
bt	00	disabled	A3 hydraulic: assignments of inputs J12/2 (CF4, led CF4) and J12/3 (CF5, led CF5)
	01	enabled: Moris EKMI valve control	
	02	enabled: GMV/NGV-A3 valve control	
	03-15	not used	
lb	01	CF1	assign inputs, when BT $\neq$ 00
	02	CF2	
	03	CF3	
	04	CF4	
	05	CF5	
Pr	no	disabled	selective access: enable reduced interfloor manoeuvre RA/RB
	YES	active	
uL	no	disabled	enable releveing, monitor inputs J12/2 (CF4, led CF4) and J12/3 (CF5, led CF5)
	YES	active	
uR	no	disabled	ENABLED with uL = YES no = microlevel with doors - OPEN (default) YES = microlevel with doors - CLOSED
	YES	active	
CS	no	disabled	hydraulic: safety circuit control
	YES	active	







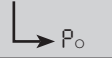











 			Option programming
Codes	Values	Meaning	Description
tF	00	standard: fire services manoeuvre EN81 (EU regulatory)	<b>fire services manoeuvre selection</b>
	01	fire services manoeuvre ASME (USA regulatory)	
	02	AUS(tralia) fire services manoeuvre	
	03-07	active	
rF	no	fire services floor only	<b>fire services manoeuvre exit mode when J12/1 drops (led FRM)</b>
	YES	to any floor	
dA	no	disabled	<b>pre-open doors (active in ramp down)</b>
	YES	active	
Sd	no	disabled	<b>inspection manoeuvre using car buttons connected to inputs 0C/1C of M1A/M1B terminal block</b>
	YES	active	
br	no	disabled	<b>block second attempt to open with floor button</b>
	YES	active	
Go	Go	in slowdown	<b>gong operation</b>
	Go.	on stop	
	Go.	on doors opening	
LU	LU	standard	<b>car light operation</b>
	LU	with KM0+: scheduled	
	LU.	always on	
CF	no	in slowdown	<b>collective down or complete manoeuvre: cancel floor call reservation</b>
	YES	on stop	
bC	no	disabled	<b>brake control with FLFRN board</b>
	YES	active	
ES	no	disabled	<b>enable energy saving function</b>
	YES	active	
GA	GA	standard: accepts any condition	<b>intermediate speed operation (AUX)</b>
	GA	with start in GV ignores the next floor	
	GA.	with AUX set does not change destination	
Jo	no	disabled	<b>monitor repeated releveling (yo-yoing)</b>
	YES	active	
EP	no	disabled	<b>with EN81-20/EN81-50 standard: car door aux contact control</b>
	YES	active	



 			Option programming
Codes	Values	Meaning	Description
P <sub>n</sub>	00	disabled	chain jumper control protocol
	01	not utilised	
	02	active	
	03-15	not used	
n <sub>U</sub>	no	disabled	simplex installation: main floor return at lower floors
	YES	active	
L <sub>t</sub>	no	disabled	lockout due to too many door close attempts
	YES	active	
ER	no	disabled	If active: <ul style="list-style-type: none"> <li>with one access: emergency stop with UM+DM (without supplementary reed switches)</li> <li>with two accesses: emergency stop with UM+DM, door selectino with SEB (DRA) (UM+DM = open side A; UM+DM+SEB =</li> </ul>
	YES	active	
E <sub>t</sub>	00	Emergency manoeuvre with CF1 input on MP2 board	NOTE: For rope lift systems only: select type of emergency (from 80.03 version)
	01	Full automatic emergency manoeuvre	
	02	Automatic emergency manoeuvre for unbalancing	
S <sub>r</sub>	S <sub>r</sub>	Overload input on FTA (M2A-4 input MP2 BOARD) if serial, ignored if parallel (used as photocell) compatible with old MP2	
	S <sub>r</sub>	Overload input J13-6 on MP2 board	
	S <sub>r</sub>	Overload on configurable Xcab input	
	S <sub>r</sub>	Both inputs can be used with separate functions.	

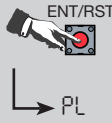

 ENT/RST  PL			Display and lights programming	
Codes	Values	Meaning	Description	
dP	FP	1 row per floor	type of floor display	
	Gr	gray		
	 of	0 to 7		floor display offset
	 Ab	no		absolute gray code, floor display
		YES		
	Bn	binary		
	 of	0 to 7		floor display offset
	 Ab	no		absolute binary code, floor display
		YES		
	7S	7 segments		
	 of	0 to 7		floor display offset
	LC	serial display		
	 of	0 to 7		floor display offset
IG	special binary IGV			
 of	0 to 7	floor display offset		
dC	FP	1 row per floor	type of car display (serial only)	
	Gr	gray		
	 of	0 to 7		car display offset
	 Ab	no		absolute gray code, car display
		YES		
	Bn	binary		
	 of	0 to 7		floor display offset
	 Ab	no		absolute binary code, car display
		YES		
	7S	7 segments		
	 of	0 to 7		floor display offset
	LC	serial display		
	 of	0 to 7		floor display offset
IG	special binary IGV			
 of	0 to 7	floor display offset		

			Display and lights programming
Codes	Values	Meaning	Description
LP	no	off - not used	universal manoeuvre and collective board: floor light function on separate floor call terminal block
	OE	occupied	
	OL	occupied flashing	
	IR	arriving, floor only	
	IC	arriving, car and floor	
oL	no	fixed	with universal manoeuvre: occupied indicator flashing
	YES	flashing	
FI	no	never together	direction arrows on even when direction is not defined (together)
	YES	together when no direction	

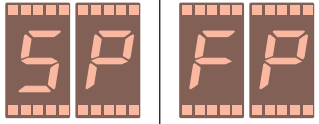
Indication on the display	Description
	Programming end

**IMPORTANT**

*In case of error (programming is interrupted) everything programmed up to that time is saved.*

## 4.4. FURTHER BOARD FUNCTIONS

### 4.4.1. LE SELECTION - FAULT LOG READING

Hold down **PROGR** until LE displays, then press **ENT/RST**. The display reads:

- If no errors are memorized, the display indicates OE;
- the display shows the first error memorized as "ER+a number" (see chapter "5 diagnostica");
  - Hold down **PROGR** to display the floor at which the error or fault occurred, as "PE+floor number"
  - If, instead of the floor number, "RF" displays, the system was resetting; if "HH" displays, the system was in inspection mode
  - Press **ENT/RST** to scroll to the next entry.
  - At the end of the scan, the display reads "FE".
- press **ENT/RST** to start the sequence again;
- otherwise press **PROGR** to display a flashing CE (cancel);
- press **ENT/RST** to cancel;
- at any time: close the safety chain to quit the procedure.

### 4.4.2. FO SELECTION - OMNIBUS PROCEDURE

To activate the manoeuvre, press **ENT/RST** once, close the safety chain:

- the car starts moving up and down;
- if any calls are made, they are handled in the normal manner;
- once the limit of 50 is reached, the process terminates;



4. to deactivate it at any time, hold **ENT/RST** down for at least 10 sec.

#### 4.4.3. EC SELECTION - TRAVEL LIMIT TEST

**IMPORTANT***See the test manual.*

#### 4.4.4. IN SELECTION - UNCONTROLLED MOVEMENT TEST

**IMPORTANT***See the test manual.*

#### 4.4.5. PA SELECTION - COMMISSIONING

1. After activation, **PR** flashes on the display;
2. this allows the car to be moved in maintenance mode, having supplied only **D4**;
3. it is deactivated when the command is repeated.





# 5 DIAGNOSTICS

## 5.1. GENERAL WARNINGS

It is assumed, for the safe use of the board, that the reader of this chapter is already familiar with the contents of heading "2.2. Avvertenze di sicurezza".



INSTALLER

## 5.2. FAULT TABLE AND FAULT FINDING

The faults are shown on the display **alternating** the error message "ER" with the **code of the identified fault**. These can be:

- (R) Recoverable faults: **the lift is still operative and restarts with next call**.
- **(NR) Non recoverable faults**: the lift goes out of order and the MP2 board must be reset; the error is deleted in case of power failure, (faults Er - 23/25/27 are kept in memory).

***Error code***      ***Fault origin and actions to be taken***

<b>Er-01</b>	<b>(R)</b>	<b>Phase reversal or phase loss</b>
<i>The board makes this control receiving at terminals J2/2(PHA) and J2/3(PHB) the signals PHA, PHB coming from ACF power supply board.</i>		
Verify: For phase reversal: <ul style="list-style-type: none"> <li>• Swap two of phases R/S/T on the terminal block (then check the rotation of the hoisting motor and door operator motor).</li> </ul> For phase loss: <ul style="list-style-type: none"> <li>• verify R/S/T phases on main input terminals.</li> <li>• verify R/S/T phases on ACF board terminals.</li> <li>• Fuses F1/F2/F3.</li> <li>• Present, on the board at inputs J2/2 (PHA) and J2/3 (PHB), approx. 13 VDC relative to GND.</li> </ul>		
<i>Note: should it be necessary to eliminate phase control, see the "programming options" table.</i>		

<b>Er-02</b>	<b>(R)</b>	<b>Thermal protection (TP) tripped</b>
<i>It is signalled when on board terminal M2A/1, a resistance value greater than 2000 ohm as to GND is detected.</i>		
<i>Hydraulic: the car goes to the lowest floor.</i>		
<i>Rope: the car stops at the nearest floor.</i>		
<i>4 min. after temperature reset, the lift returns into service. Showing on the display a countdown.</i>		
Verify: <ul style="list-style-type: none"> <li>• Connection to GND and thermistor resistance value and any other contact wired in series on the same circuit.</li> <li>• Direct wiring to GND (without thermistors).</li> <li>• Control cabinet ground connection of main line.</li> </ul>		



Er-03	(R)	<b>No closure of high speed (GV) / low speed (PV) / (power (P) for 1 speed system) / retiring cam (RP)</b>
<i>At start up the board does not measure 24 VDC on input J11/1 (FSC) to confirm excitation of the high speed (GV) / low speed (PV) contactors.</i>		
<p>Verify:</p> <ul style="list-style-type: none"> <li>• Excitation of the high speed (GV) / low speed (PV) / power (P with 1 speed) contactors</li> <li>• Excitation, if installed, of the RP contactor and retiring cam.</li> <li>• Voltage at the end of safety chain, after the landing door lock contacts (when activated by the retiring cam).</li> <li>• Input voltage at board terminals J8/8 (PV, led PV), J8/5 (GV, led GV).</li> <li>• Input voltage with controls activated at board terminals J8/7 (PV, led PV), J8/6 (GV, led GV).</li> <li>• With the high speed (GV) / low speed (PV) contactors excited, their auxiliary contacts wired between the +24 terminal and the board's J11/1 (FSC, led IA) connector input.</li> </ul>		
Er-04	(R)	<b>No closure of the up (S) / down (D) contactors</b>
<i>At start up the board does not measure 24 VDC on input J11/2 (UD, led IB) to confirm excitation of the up (S) / down (D) contactors.</i>		
<p>Verify:</p> <ul style="list-style-type: none"> <li>• Excitation of the up (S) / down (D) contactors.</li> <li>• Voltage at terminals CRS/CRD or CRSB/CRDB (top and bottom floor phase plug contactors).</li> <li>• Input voltage at board terminals J8/1 (S, led S), J8/4 (D, led D).</li> <li>• Input voltage with controls activated at board terminals J8/2 (S, led S), J8/3 (D, led D).</li> <li>• NC contact of the electrical reciprocal of the up (S)/down (D) contactors.</li> <li>• With the up (S) or down (D) contactor excited, the corresponding auxiliary contacts connected between +24 and board input J11/2 (UD, led IB).</li> <li>• With amendment A3: <ul style="list-style-type: none"> <li>▪ Gearless: no main brake de-excitation control contact closure; Gearless: no auxiliary brake de-excitation control contact closure.</li> <li>▪ No excitation of the brake contact control contactors, or their contacts are defective.</li> <li>▪ No closure of the de-excitation control contact of the speed governor coil (Montanari or similar).</li> </ul> </li> </ul>		
Er-05	(R)	<b>No closure of the power contactors (TL1 / TL2)</b>
<i>At start up the board does not measure 24 VDC on input J11/5 (CCS, led CCS) to confirm excitation of the power contactors (TL1 / TL2).</i>		
<p>Verify:</p> <ul style="list-style-type: none"> <li>• Excitation of the power contactors (TL1 / TL2)</li> <li>• Voltage at the up (S) / down (D) contactor contacts which control the power contactors (TL1 / TL2).</li> <li>• Variable speed drive fault signal contact (see error on the variable speed drive keypad).</li> <li>• With the power (TL1 / TL2) contactors excited, the corresponding auxiliary contacts connected between +24 and board input J11/5 (CCS, led CCS).</li> </ul>		
Er-06	(R)	<b>No door closure</b>
<i>Case 1: once door closure has timed out (<math>t_5 = 15</math> seconds), the board does not receive the door contacts closed signal at terminal J7/10 (D4, led D4). Led D4 does not light up.</i>		
<p>Verify:</p> <ul style="list-style-type: none"> <li>• Car door or door lock contacts (if no retiring cam is present).</li> <li>• Minirelay or door closure contactor does not excite.</li> <li>• Door closure limit switch is open.</li> <li>• NC contact of the electrical reciprocal of the door open contactor.</li> <li>• No control signal output from the board at terminal J6/10 (CPO, led CP).</li> <li>• No power to the car door motor (if three-phase).</li> <li>• No power to the car door regulator board (single-phase 220 VAC).</li> <li>• No closure signal to the car door regulator board (single-phase 220 VAC).</li> <li>• Delay <math>t_5</math> timeout (15 seconds).</li> </ul>		
<i>Case 2: once door closure has timed out (<math>t_5 = 15</math> seconds), the 24VDC voltage output by the door closed contactor remains active at input J11/3 (DRA, led IC) or J11/4 (DRB, led ID).</i>		
<p>Verify:</p> <ul style="list-style-type: none"> <li>• No opening of the door closure limit switch.</li> <li>• With the operator power and running disconnect the door closure contact from input J11/3 (DRA, led IC) or, if double access, contact J11/4 (DRB, led ID).</li> </ul>		



Er-07	(R)	<b>No door opening</b>
<i>Case 1: once door opening has timed out (<math>t_5 = 15</math> seconds), the signal indicating that the door contacts are open remains active at terminal J7/10 (D4, led D4). Led D4 remains on.</i>		
Verify:		
<ul style="list-style-type: none"> <li>• Door opening contactor does not excite.</li> <li>• Door opening limit switch is open.</li> <li>• NC contact of the electrical reciprocal of the door closure contactor.</li> <li>• No control signal output from board terminal J6/8 (led APB) and J6/9 (led APA).</li> <li>• No power to the car door motor (if three-phase).</li> <li>• No power to the car door regulator board (single-phase 220 VAC).</li> <li>• No open signal to the car door regulator board (single-phase 220 VAC).</li> </ul>		
<i>Case 2: once door opening has timed out (<math>t_5 = 15</math> seconds), the 24VDC voltage from the doors open contactor remains active at input J11/3 (DRA, led IC) or J11/4 (DRB, led ID).</i>		
Verify:		
<ul style="list-style-type: none"> <li>• No opening of the open limit switch.</li> <li>• Opening timeout, set in <math>t_5</math> (15 seconds).</li> </ul>		
Er-08	(R)	<b>UM count error</b>
<i>An extra pulse is counted in the up count sequence.</i>		
Verify:		
<ul style="list-style-type: none"> <li>• Presence of all magnetic strips.</li> <li>• Correct positioning of the magnetic strips relative to the UM reed switch.</li> <li>• Minimum distance between consecutive strips to enable pulse counting.</li> <li>• Failure of the flexible cable.</li> </ul>		
Er-09	(R)	<b>DM count error</b>
<i>An extra pulse is counted in the down count sequence.</i>		
Verify:		
<ul style="list-style-type: none"> <li>• Presence of all magnetic strips.</li> <li>• Correct positioning of the magnetic strips relative to the DM reed switch.</li> <li>• Minimum distance between consecutive strips to enable pulse counting.</li> <li>• Failure of the flexible cable.</li> </ul>		
Er-10	(R)	<b>D1 safety chain control</b>
<i>When the car is moving, no signal to the board at input J7/4 (D1, led D1).</i>		
Verify:		
<ul style="list-style-type: none"> <li>• All contacts in the safety chain upline of input J7/4 (D1, led D1) - see the wiring diagram.</li> </ul>		
Er-11	(R)	<b>D3 safety chain control</b>
<i>When the car is moving, no signal to the board at input J7/8 (D3, led D3).</i>		
Verify:		
<ul style="list-style-type: none"> <li>• All contacts in the safety chain between input J7/4 (D1, led D1) and J7/8 (D3, led D3) - see the wiring diagram.</li> </ul>		
Er-12	(R)	<b>D4 safety chain control (lacking)</b>
<i>When the car is moving, no signal to the board at input J7/10 (D4, led D4).</i>		
Verify:		
<ul style="list-style-type: none"> <li>• All contacts in the safety chain between input J7/8 (D3, led D3) and J7/10 (D4, led D4) - see the wiring diagram.</li> </ul>		
Er-13	(R)	<b>Stopped away from floor</b>
<i>When the car arrives at the floor inputs UM (M2A/2) and DM (M2A/3) are missing on the board. Rope, 1 or 2 speeds: the car resets.</i>		
Verify:		
<ul style="list-style-type: none"> <li>• Brake regulation.</li> <li>• Magnetic strip position.</li> <li>• Slowdown distance.</li> </ul>		



Er-14	(R)	<b>D4 safety chain control (present)</b>
<i>With the car moving, no signal to board inputs J11/1 (FSC, led IA) and J11/2 (UD, led IB) simultaneously.</i>		
Verify: <ul style="list-style-type: none"> <li>All contacts in the safety chain downline of input J7/10 (D4, led D4) - see the wiring diagram.</li> </ul>		
Er-15	(R)	<b>Safety circuit control for uncontrolled movement</b>
<i>On arrival at the floor with doors open and UM/DM reed switches present, no signal to board inputs RLD and RLS (see cabinet wiring diagram)</i>		
Verify: <ul style="list-style-type: none"> <li>Operation of RLS / RLD reed switches.</li> <li>Magnetic strip position.</li> <li>Operation of the safety circuit.</li> </ul>		
Er-16	(R)	<b>Door blocked due to photocell occlusion</b>
<i>Timeout (timer = PE) due to photocell occlusion.</i>		
Verify: <ul style="list-style-type: none"> <li>Delay programmed in PE.</li> <li>Photocell operation.</li> </ul>		
Er-17	(NR)	<b>No high speed (GV) / low speed (PV) contactor opening</b>
<i>Before starting, or for more than 20 seconds on arrival at the floor, the board reads 24 VDC at input J11/1 (FSC, led IA): the high speed (GV) / low speed (PV) contactors are still attracted.</i>		
Verify: <ul style="list-style-type: none"> <li>Mechanical blockage of the high speed (GV) / low speed (PV) contactors.</li> <li>Outputs J8/6 (GV, led GV) and J8/7 (PV, led PV) always active on the board.</li> </ul>		
Er-18	(NR)	<b>No opening of the up (S) / down (D) contactors</b>
<i>Before starting, or for more than 20 seconds on arrival at the floor, the board reads 24 VDC at input J11/2 (UD, led IB): the up (S) / down (D) contactors are still attracted.</i>		
Verify: <ul style="list-style-type: none"> <li>Mechanical blockage of the up (S) / down (D) contactors.</li> <li>Outputs J8/2 (S, led S) and J8/3 (D, led D) always active on the board.</li> <li>Hydraulic: the releveing circuit, if independent of the board.</li> </ul>		
Er-19	(NR)	<b>Contactors TL1/TL2 do not open</b>
<i>Before starting, or for more than 20 seconds on arrival at the floor, the board reads 24 VDC at input J11/5 (CCS, led CCS): the power (TL1/TL2) contactors are still attracted.</i>		
Verify: <ul style="list-style-type: none"> <li>Mechanical blockage of the power contactor (TL1 / TL2).</li> <li>Outputs J8/2 (S, led S) and J8/3 (D, led D) always active on the board.</li> <li>Variable speed drive power outputs enabling (see cabinet wiring diagram)</li> </ul>		
Er-20	(NR)	<b>Excessive time at high speed</b>
<i>Via reed switches UM / DM, the board detects high speed travel between consecutive floors of more than 20 seconds (time adjustable up to 90 seconds in parameter t0). Hydraulic: the car goes to the lowest floor. Rope: the car remains where it is.</i>		
Verify: <ul style="list-style-type: none"> <li>During commissioning, check that the distance (in metres) between consecutive floors is greater than that obtained by multiplying the car speed (m/s) by 20 seconds; if the result is greater, the timer <math>\tau_0</math> must be adjusted or a dummy floor must be created.</li> <li>Operation of the UM / DM reed switches.</li> <li>Magnetic strip position.</li> </ul>		



- What can move the car at low speed or stop it between floors with the contactors excited (the 24 VDC at inputs J11/1 (FSC, led IA) and J11/2 (UD, led IB) remains):
  - Lack of a phase to the hoist motor or hydraulic power pack.
  - Rope: hoist brake not excited (but leaving the floor is still permitted).
  - Hydraulic: high speed solenoid valve not powered.
  - Variable speed drive: variable speed drive in error and car stopped between floors
  - Variable speed drive: no high speed signal to the variable speed drive.

Er-21	(NR)	Excessive time at low speed
<p>Via the UM / DM reed switches, the board detects a low speed travel time between the start of slowdown and the destination floor in excess of 20 seconds.            Hydraulic: the car goes to the lowest floor.            Rope: the car remains where it is.</p>		
<p>Verify:</p> <ul style="list-style-type: none"> <li>• Operation of the UM / DM reed switches.</li> <li>• Magnetic strip position.</li> <li>• What can impede or delay arrival of the car at the floor, in the low speed travel space (PV), with contactors excited (24 VDC to board inputs J11/1 (FSC, led IA) and J11/2 (UD, led IB) is not lacking):               <ul style="list-style-type: none"> <li>▪ Rope: lack of a phase to the hoist motor.</li> <li>▪ Rope, 2 speeds: hoist brake not excited at low speed.</li> <li>▪ Variable speed drive: variable speed drive in error and car stopped between floors.</li> <li>▪ Variable speed drive: no low speed signal to the variable speed drive.</li> <li>▪ Variable speed drive: insufficient motor torque.</li> </ul> </li> </ul>		

Er-22	(NR)	Excessive time taken to leave the floor
<p>Via the UM / DM reed switches, the board detects failure to leave the floor within a time of 10 seconds.            Hydraulic: the car goes to the lowest floor.            Rope: the car remains where it is.</p>		
<p>Verify:</p> <ul style="list-style-type: none"> <li>• Operation of the UM / DM reed switches.</li> <li>• What can impede or delay the car leaving the floor within 10 seconds of excitation of the contactors (the 24 VDC to board inputs J11/1 (FSC, led IA) and J11/2 (UD, led IB) is not lacking):               <ul style="list-style-type: none"> <li>▪ Lack of a phase to the hoist motor or hydraulic power pack.</li> <li>▪ Rope: hoist brake not excited.</li> <li>▪ Hydraulic: down solenoid valve not powered.</li> <li>▪ A3 hydraulic: 2nd down solenoid valve not powered.</li> <li>▪ Hydraulic: star/delta solenoid valve not powered.</li> <li>▪ Hydraulic: no switching of the star/delta contactors.</li> <li>▪ Hydraulic: no Soft Starter startup.</li> <li>▪ Variable speed drive: variable speed drive in error.</li> <li>▪ Variable speed drive: no speed signal to the variable speed drive.</li> </ul> </li> </ul>		

Er-23	(NR)	Safety chain contacts between "D1" and "D2" tripped
<p>Signal to input J7/6 (D2, D2 LED) lacking, but signal to input J7/4 (D1, D1 LED) present: after reset.            Hydraulic: the car goes to the lowest floor.            Rope: the car remains where it is.</p>		
<p>Travel limit checks:</p> <ul style="list-style-type: none"> <li>• Operation of the UM / DM reed switches.</li> <li>• Operation and positioning of slowdown controls CRS/CRD or CRSB/CRDB.</li> <li>• Distance between magnetic slowdown strip at the top and lowest floors and slowdown controls CRS/CRD or CRSB/CRDB.</li> <li>• Distance of the overtravel contact from the top or lowest floors.</li> <li>• The car must travel, under any loading conditions, a few cm at low speed before it receives the stop signal.</li> <li>• Variable speed drive: brake regulation (opening and compression).</li> </ul>		
<p>Other contact checks:</p> <ul style="list-style-type: none"> <li>• Safety chain contacts between inputs J7/4 (D1, led D1) and J7/6 (D2, led D2): see control cabinet wiring diagram</li> </ul>		



Er-24	<b>(NR)</b>	<b>Releveling failure</b>
<p>In hydraulic lift systems, the board controls releveling when J11/5 (CCS, led CCS) is receiving the "active" signal from the safety circuit and the UM or DM reed switch signal is lacking, to indicate that the car has moved up or down relative to the floor. N.B. If in error, the car goes to the lowest floor.</p>		
<p><b>Case 1:</b> the car relevels when travelling upwards but does not close the DM reed switch within 15 seconds; the contactors remain excited and continue to relevel (releveling is stopped by the thermistors or after a timeout of 15 seconds).</p>		
<p>Verify:</p> <ul style="list-style-type: none"> <li>• Operation of the DM reed switch.</li> <li>• Lack of power or single-phase power to the motor.</li> <li>• Soft Starter failure.</li> <li>• Overloaded car.</li> <li>• Failure to excite of a motor power contactor.</li> <li>• Oil delivery valve closed.</li> </ul>		
<p><b>Case 2:</b> in the presence of the up or down releveling signal, the contactors do not excite within 15 seconds (releveling circuit malfunction).</p>		
<p>Verify:</p> <ul style="list-style-type: none"> <li>• Safety circuit and GV contactor contacts in parallel with the car door and landing door lock contacts.</li> </ul>		
<p><b>Case 3:</b> relevels in downwards travel but the UM reed switch does not close within 15 seconds.</p>		
<p>Verify:</p> <ul style="list-style-type: none"> <li>• Operation of the UM reed switch.</li> <li>• No power to or mechanical blockage of the down valve.</li> <li>• Failure to excite of a down valve power contactor.</li> </ul>		
Er-25	<b>(NR)</b>	<b>Safety circuit malfunction (it did not close at the floor)</b>
<p>In hydraulic systems, the board controls the status of the safety circuit via a 24 VDC signal at J11/5 (CCS, CCS LED): the "active" safety circuit signal must be present when the car is at the floor. N.B. If in error, the car goes to the lowest floor and remains there out of service.</p>		
<p>Verify:</p> <ul style="list-style-type: none"> <li>• With the car at the floor: <ul style="list-style-type: none"> <li>▪ 24 VDC at input J11/5 (CCS, led CCS).</li> <li>▪ Voltage present at terminals RZA/RZB</li> <li>▪ Check the safety circuit.</li> </ul> </li> <li>• Defective board (if reporting an error with the signal present).</li> </ul>		
Er-26	<b>(NR)</b>	<b>Reset failure (CRS/CRD open)</b>
<p>During reset, when the up or down signal is sent, the board does not have 24 VDC at J11/1 (FSC, led IA) after two/four attempts, or does not receive 24 VDC at J11/2 (UD, led IB).</p>		
<p>Verify:</p> <ul style="list-style-type: none"> <li>• CRS/CRD or CRSB/CRDB phase plugs.</li> <li>• The up/down board control signals at outputs J8/2(S, led S) and J8/3(D, led D).</li> <li>• The reciprocal contacts in series with the up (S)/down(D) contactors.</li> <li>• The up (S) / down (D) contactor coils.</li> </ul>		



Er-27	<b>(NR)</b>	<b>Safety circuit malfunction (it did not open when the floor was left)</b>
<i>In hydraulic systems, the board controls the status of the safety circuit via a 24 VDC signal at J11/5 (CCS, led CCS): the "active" safety circuit signal must terminate when the car is away from the floor. The control is run when the car transits the slowdown strip at the destination floor: if in error, the car is moved to the lowest floor and remains out of service.</i>		
Verify: <ul style="list-style-type: none"><li>• If 24 VDC is present at input J11/5(CCS, led CCS) with the car away from the floor, verify:<ul style="list-style-type: none"><li>▪ Check the safety circuit.</li></ul></li></ul>		
Er-28	<b>(NR)</b>	<b>UM reed count error</b>
<i>The board controls operation of the UM/DM reed switches: 24 VDC present when the REED switch is closed.</i>		
Verify: <ul style="list-style-type: none"><li>• Operation of the UM reed switch.</li><li>• Presence and positioning of the magnetic strips.</li><li>• Condition of the flexible cables.</li><li>• Presence of 24 VDC at the common contact of the UM/DM reed switches.</li></ul>		
Er-29	<b>(NR)</b>	<b>DM reed count error</b>
<i>The board controls operation of the UM/DM reed switches: 24 VDC present when the REED switch is closed.</i>		
Verify: <ul style="list-style-type: none"><li>• Operation of the DM reed switch.</li><li>• Presence and positioning of the magnetic strips.</li><li>• Condition of the flexible cables.</li><li>• Presence of 24 VDC at the common contact of the UM/DM reed switches.</li></ul>		
Er-30	<b>(NR)</b>	<b>Rope: movement detected while testing clamp "FA" (clamp "B" does not hold)</b>
Verify: <ul style="list-style-type: none"><li>• Check clamp "B"</li></ul>		
	<b>(NR)</b>	<b>Hyd: Operation test of the separate opening of the 1<sup>st</sup> valve failed</b>
<i>During testing at the lowest floor with the doors closed, the system releveled when the 1st valve opened.</i>		
Verify: <ul style="list-style-type: none"><li>• Operation of the 2nd valve.</li></ul>		
Er-31	<b>(NR)</b>	<b>Rope: movement detected while testing prove clamp "FB" (clamp "A" does not hold)</b>
Verify: <ul style="list-style-type: none"><li>• Check clamp "A"</li></ul>		
	<b>(NR)</b>	<b>Hyd: Operation test of the separate opening of the 2<sup>st</sup> valve failed</b>
<i>During testing at the lowest floor with the doors closed, the system releveled when the 2nd valve opened.</i>		
Verify: <ul style="list-style-type: none"><li>• Operation of the 1st valve.</li></ul>		
Er-32	<b>(NR)</b>	<b>Error in the return to service sequence following out of service</b>
<i>For system in public service, the car, when reset after out of service, is moved to the top floor, in automatic, and executes all calls travelling downwards and monitors door opening. If the sequence does not complete successfully, an error is reported.</i>		
Er-40	<b>(NR)</b>	<b>Flash memory programming error</b>
<ul style="list-style-type: none"><li>• Replace the MP2 board.</li></ul>		





Er-41	<b>(NR)</b>	<b>Insufficient power voltage (+24 V)</b>
<i>The board verifies the power voltage between inputs J2/1 (GND) and J2/4 (24 VDC).</i>		
Verify:		
<ul style="list-style-type: none"> <li>• 18 VAC at the transformer output and at the input to the ACF board.</li> <li>• 24 VDC at the ACF board output.</li> <li>• Power voltage and fuses F1/F2/F3.</li> </ul>		
Er-42	<b>(NR)</b>	<b>Programming data entry error</b>
<ul style="list-style-type: none"> <li>• Call ELETTRQUADRI S.r.l.</li> </ul>		
Er-44	<b>(NR)</b>	<b>Serial communications to FLFRN board error</b>
Verify:		
<ul style="list-style-type: none"> <li>• Check communications with FLFRN board.</li> </ul>		
Er-47	<b>(NR)</b>	<b>Call button blocked</b>
<i>The board checks that a call button has been pressed.</i>		
Verify:		
<ul style="list-style-type: none"> <li>• Check the operation of the call buttons (car/floor).</li> <li>• Check the status of the call inputs on the boards.</li> </ul>		
Er-67	<b>(R)</b>	<b>When the front doors are opened, monitoring of the front door auxiliary contact opening</b>
Verify:		
<ul style="list-style-type: none"> <li>• Operation of the front door auxiliary contact.</li> </ul>		
Er-68	<b>(R)</b>	<b>When the front car doors close, monitoring of the front door auxiliary contact closing</b>
Verify:		
<ul style="list-style-type: none"> <li>• Operation of the front door auxiliary contact.</li> </ul>		
Er-69	<b>(R)</b>	<b>When the rear doors are opened, monitoring of the rear door auxiliary contact opening</b>
<i>The board checks the status of the input (see wiring diagram)</i>		
Verify:		
<ul style="list-style-type: none"> <li>• Operation of the rear door auxiliary contact.</li> </ul>		
Er-70	<b>(R)</b>	<b>When the rear car doors close, monitoring of the rear door auxiliary contact closing</b>
<i>The board checks the status of the input (see wiring diagram)</i>		
Verify:		
<ul style="list-style-type: none"> <li>• Operation of the rear door auxiliary contact.</li> </ul>		
Er-71	<b>(R)</b>	<b>TF failure when driving (bolt opens after D4)</b>
Er-72	<b>(R)</b>	<b>TF not energised on departure (bolt opens after D4)</b>
Er-73	<b>(R)</b>	<b>Serial communication to car boards error</b>
Er-74	<b>(R)</b>	<b>Communications error with MP8120 board</b>
Er-75	<b>(R)</b>	<b>X-Door board/s communication error</b>
Er-76	<b>(R)</b>	<b>Machine local temperature error (with serial system and overload input set on "XCAB and MP, input J13-6)</b>





Er-80	<b>(NR)</b>	<b>Releving error with UM/DM reed switch</b>
<i>With the car at the floor and the doors open, the signals of both reed switches UM (M2A/2) and DM (M2A/3) are lacking during releving.</i>		
Verify:		
<ul style="list-style-type: none"> <li>• Operation of UM/DM reed switch (variable speed drive: RLS/RLD).</li> <li>• Magnetic strip position.</li> </ul>		
Er-81	<b>(NR)</b>	<b>Releving error with safety circuit</b>
<i>With the car at the floor and the doors open, the car exits the doors zone during releving.</i>		
Verify:		
<ul style="list-style-type: none"> <li>• Operation of UM/DM reed switch (variable speed drive: RLS/RLD).</li> <li>• Magnetic strip position.</li> </ul>		
Er-82	<b>(NR)</b>	<b>Malfunction of the Moris EKMI or GMV/NGV-A3 valve</b>
<i>During operation, the following faults are reported:</i>		
<ul style="list-style-type: none"> <li>• Moris EKMI valve = no 24 VDC at input J12/3(CF5, led CF5).</li> <li>• GMV/NGV-A3 valve = for longer than set in timer P8, inputs J12/2 (CF4, led CF4) and J12/3 (CF5, led CF5) are simultaneously either lacking or present.</li> </ul>		
Verify:		
<ul style="list-style-type: none"> <li>• Operation and information of the Moris EKMI board.</li> <li>• Operation and information of the GMV/NGV-A3 board.</li> </ul>		
Er-83	<b>(NR)</b>	<b>Excessive releving error</b>
<i>With the car at the floor, it attempts to relevel every 60 s in both directions (yo-yo effect) at most 10 times.</i>		
Verify:		
<ul style="list-style-type: none"> <li>• Magnetic strip position.</li> <li>• Releving frequency/speed.</li> <li>• Oil leak.</li> </ul>		
Er-84	<b>(NR)</b>	<b>Error: doors locked due to too many errors</b>
<i>The maximum number of door open or close cycles has been exceeded, displayed after error Er-06 or Er-07.</i>		
Verify:		
<ul style="list-style-type: none"> <li>• See error Er-06.</li> <li>• See error Er-07.</li> </ul>		
Er-85	<b>(NR)</b>	<b>Fire services fault</b>
Check the fault on the variable frequency drive		
Er-86	<b>(NR)</b>	<b>Jumpers on car door contacts</b>
<i>The board verifies the presence of input J7/8 (D3, led D3).</i>		
Verify:		
<ul style="list-style-type: none"> <li>• Door contacts.</li> </ul>		
Er-87	<b>(NR)</b>	<b>Jumper on the landing door locks</b>
<i>The board verifies the presence of input J7/10 (D4, led D4).</i>		
Verify:		
<ul style="list-style-type: none"> <li>• Landing door lock contacts.</li> </ul>		
Er-88	<b>(NR)</b>	<b>The bypass relay does not excite</b>
<i>No excitation of the jumper test relay/contactator on the car doors and door locks.</i>		
Verify:		
<ul style="list-style-type: none"> <li>• Operation of the PPCS contactor.</li> </ul>		



Er-89	<b>(NR)</b>	<b>Presence of car door auxiliary contact</b>
<i>The board checks the presence of car doors auxiliary contact input signal.</i>		
Er-90	<b>(NR)</b>	<b>Communications error between microprocessor board and inverter</b>
Er-94	<b>(NR)</b>	<b>In "Fire services management via microprocessor board" mode: TF contactor does not open (brake remains open after stop)</b>
Er-A1	<b>(NR)</b>	<b>Generic brake error</b>
Er-E0	<b>(NR)</b>	<b>CRDB / CRSB MALFUNCTION (bistable ramp down control and top/lowest floor resetting switches)</b>
<i>Checking the operation of CRDB.</i>		
Er-E1	<b>(NR)</b>	<b>CRDB / CRSB MALFUNCTION (bistable ramp down control and top/lowest floor resetting switches)</b>
<i>Checking the operation of CRSB.</i>		
Er-E2	<b>(NR)</b>	<b>CRDB MALFUNCTION (bistable ramp down control and lowest floor resetting switch)</b>
<i>Checking the operation of CRDB.</i>		
Er-E3	<b>(NR)</b>	<b>CRSB MALFUNCTION (bistable ramp down control and top floor resetting switch)</b>
<i>Checking the operation of CRSB.</i>		
Er-E4	<b>(NR)</b>	<b>RIDB MALFUNCTION (bistable lowest floor inspection ramp down switch)</b>
<i>Checking the operation of RIDB.</i>		
Er-E5	<b>(NR)</b>	<b>RISB MALFUNCTION (bistable ramp down and top floor inspection switch)</b>
<i>Checking the operation of RISB.</i>		
Er-E6	<b>(NR)</b>	<b>RIDB STAYS CLOSED WITH CAR AT LOWEST FLOOR (bistable lowest floor inspection ramp down switch)</b>
<i>Checking the operation of RIDB.</i>		
Er-E7	<b>(NR)</b>	<b>RISB STAYS CLOSED WITH CAR AT HIGHEST FLOOR (bistable highest floor inspection ramp down switch)</b>
<i>Checking the operation of RISB.</i>		



# 6 BOARD FUNCTIONS AND LAYOUT

## 6.1. GENERAL WARNINGS

It is assumed, for the safe use of the board, that the reader of this chapter is already familiar with the contents of heading "2.2. Avvertenze di sicurezza".



INSTALLER

## 6.2. INSULATION TEST



**IMPORTANT**

*During electrical insulation test all sockets must be removed from MP2 board and from its expansions.*

Further informations on the procedure are stated on the control cabinet specific wiring diagram.

## 6.3. SWITCH FUNCTIONS

### 6.3.1. UM/DM REED

With only two contacts (UM / DM), in combination with four magnetic strips per floor, the following functions are available:

- Floor count (UM for up and DM for down travel)
- Start of slowdown (stop for 1 speed systems)
- Stop (both UM / DM are present)
- Doors zone (both UM / DM are present)

**It is possible to “reverse” the slowdown strips if the slowdown distance is greater than half the floor spacing.**

### 6.3.2. RZA / RZB REED SWITCH CONTACTS

The two reed switch contacts (RZA / RZB) are contained in the same housing and, in combination with a single magnetic strip per floor, actuate the safety circuit which defines and enables:

- Hydraulic: the releveling/door pre-opening zone.
- Rope: the door pre-open and/or releveling zone.



### 6.3.3. DMS / DMD REED SWITCH CONTACTS

The DMS / DMD reed switches are used for the "short floor" function, i.e. when the space between two floors is less than the slowdown distance + 400 mm.

The DMS reed switch (up) and DMD reed switch (down) enable:

- If there is insufficient physical space to slowdown between the two floors, they initiate slowdown before the floor immediately preceding the destination floor
- They move the car in low speed between the two closely spaced floors

Depending on the order data, the wiring diagrams normally include an enclosure indicating how to lay out the additional magnetic strips for the "short floors".

### 6.3.4. SLOWDOWN / PHASE PLUG CONTROL AT THE TOP AND LOWEST FLOORS (CRSB/CRDB)

Both bistable **CRS/CRD** contacts, located at the end floors, act directly on the board inputs, forcing the car to slow down and preventing it from travelling beyond its travel limits at high speed if it arrives "out of step".

They must be positioned at a distance proportional to the speed of the system (see the specifications on the cabinet wiring diagram).

## 6.4. BOARD TECHNICAL SPECIFICATIONS

### 6.4.1. MP2 BOARD

**MP2-NR/ND** | This is the motherboard, located in the control cabinet, responsible for serial communications, via inputs J3/2-3, with the "car serial boards".

Existing in the following versions:

<b>MP2 - NR</b>	Universal	Max 12 stops
<b>MP2 - ND</b>	Simplex collective down	Max 12 stops
	Simplex collective complete (up and down)	Max 8 stops
	Duplo/duplex/triplex/quadruplex collective down	Max 12 stops
	Duplex/triplex/quadruplex collective complete (up and down)	Max 8 stops

### 6.4.2. EXP EXPANSION BOARDS

Two versions existing:

<b>EXP - R</b>	Universal	+ 12 stops
<b>EXP - D</b>	Universal or duplo	+ 12 stops
	Collective down (simplex/duplex/triplex/quadruplex)	+ 12 stops
	Complete collective manoeuvre (up and down) simplex/duplex/triplex/	+ 8 stops
	quadruplex	



#### **IMPORTANT**

*The maximum number of available stops for the expansions is 32*



### 6.4.3. P2C MINIRELAY POSITION BOARDS (WITH DECIMAL OUTPUT - ONE ROW PER FLOOR)

Two versions existing:

P2C - 4	With 4 mini-relays
P2C - 8	With 8 mini-relays



#### **IMPORTANT**

*Each minirelay has 2 contacts which, with the 2 separate commons, can be used for “position, present, or next direction”.*

### 6.4.4. PUC MINI-RELAY POSITION BOARDS (FOR CODED DISPLAY)

Two versions existing:

PUC - 5	With 6 mini-relays per display with the “Gray” or “binary” logic
PUC - 13	With 13 mini-relays per display with the “7 segment/a,b,c,d.....” logic



#### **IMPORTANT**

*Maximum current per output 2 Ampere at 24 VAC/DC.*

### 6.4.5. ACF BOARD

Has the following functions:

- 24 V DC power supply (it transforms the 18 VAC arriving from the transformer).
- Phase sampling (it transforms the mains voltage into two low voltage signals sent to terminals J2/2 and J2/3 used by the board to monitor the phases).

### 6.4.6. DUPLO CONNECTION BOARD (ONLY WITH SEPARATE “ARRIVING” INDICATIONS FOR THE TWO CABINETS)

This installs in just one of the two cabinets and connects to the floor calls of both lifts and the flat cables for external calls and serial communications.

Two versions existing:

DUPLO - 20	For connection with a 20 pole cable to the MP2 board
DUPLO - 16	For connection with a 16 pole cable to the EXP expansion boards

### 6.4.7. TPX CONNECTION DIAGRAM

Installs in a Triplex in cabinet B or in a Quadruplex in cabinets B and C to simplify and facilitate connection of external calls between the cabinets using flat cables.

Two versions existing:

<b>TPX - 20</b>	For connection of the 20 pole cables between the MP2 boards
<b>TPX - 16</b>	For connection of the 16 pole cables between the EXP expansion boards

### 6.4.8. MPX\_CAN BOARD

<b>MPX_CAN</b>	Connection/control board Variable speed drive via MP2 board
----------------	---

### 6.4.9. X-CAB BOARD

<b>XCAB</b>	Serial connection board between the cabinet and car for:
	<ul style="list-style-type: none"> <li>• Reed inputs UM-DM (input M4.2 and M4.3)</li> <li>• Bistable inputs CRSB-CRDB (input M2.2 and M2.3)</li> <li>• Inspection limits bistable inputs RISB-RIDB (input M6.2 and M8.2)</li> <li>• Car roof inspection panel inputs (M3 connector)</li> <li>• 6 inputs configurable via QuickUp APP:             <ul style="list-style-type: none"> <li>• Overload</li> <li>• Full load</li> <li>• DMS-DMD reed switch</li> <li>• RLS-RLD reed switch</li> <li>• Access B emergency stop reed switch</li> <li>• RA-RB reed switch (selective for short distance between floors)</li> <li>• FRM car key</li> <li>• SRV car key</li> </ul> </li> <li>• Car call inputs (Connector M18)</li> <li>• Position Indicator outputs (Connector M19)</li> <li>• Direction Indicator outputs (Connector M5)</li> <li>• Overload signalling output (Connector M7)</li> <li>• Gong signalling output (Connector M9)</li> <li>• 4 outputs configurable via QuickUp APP (Connector M7)</li> </ul>

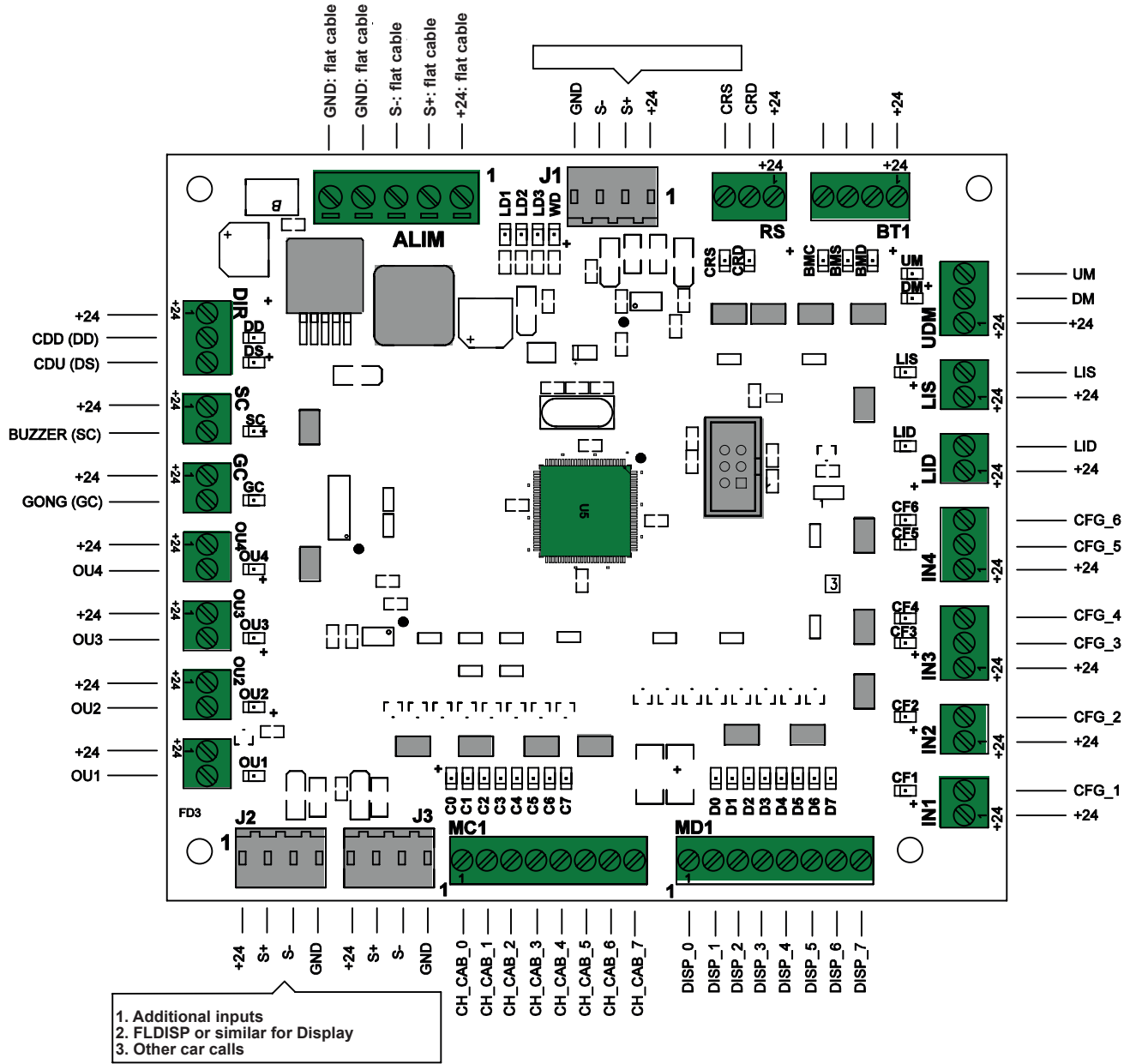



### 6.4.10. X-DOOR BOARD

#### X-DOOR

Serial connection board between the cabinet and car for door operators management:

- 24VDC power supply and photocell contact input (connector M5)
- Door open button input N.O. (connector JM)
- Door close button input N.O. (connector M7)
- Mobile rib contact input (connector M8)
- Limit switch input (connector M9)
- Car doors auxiliary contact input EN 81.20 (connector M10)
- Operator clean controls output (connector M2)
- Nudging command output (connector M3)

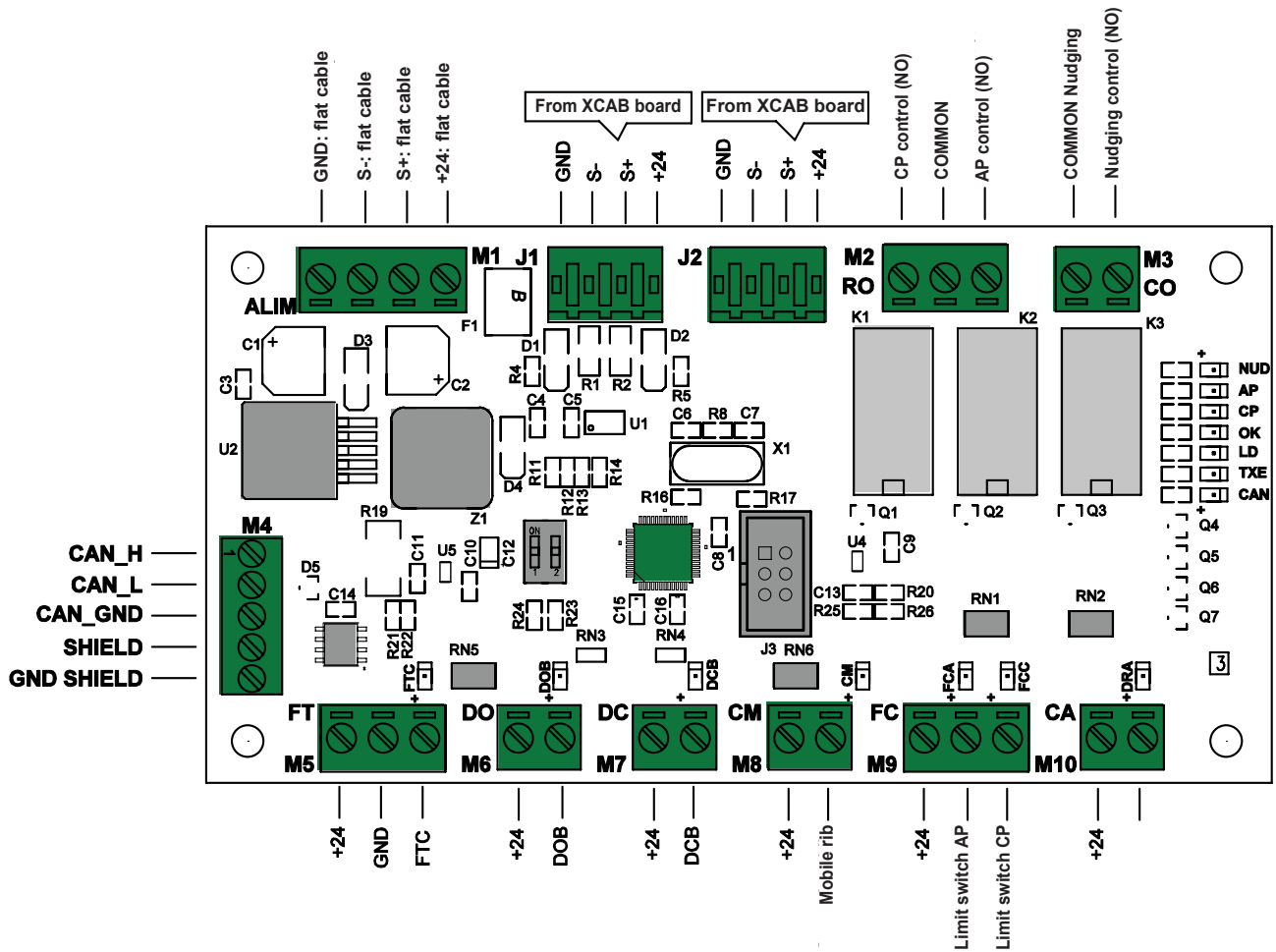





### 6.4.11. MP8120 BOARD

Pit board:

- Lower floor emergency lock contact input (M1)
- BF1 pit maintenance control panel input (M2)
- Pit access memory reset key input (M3)
- Pit semaphore output (J4)

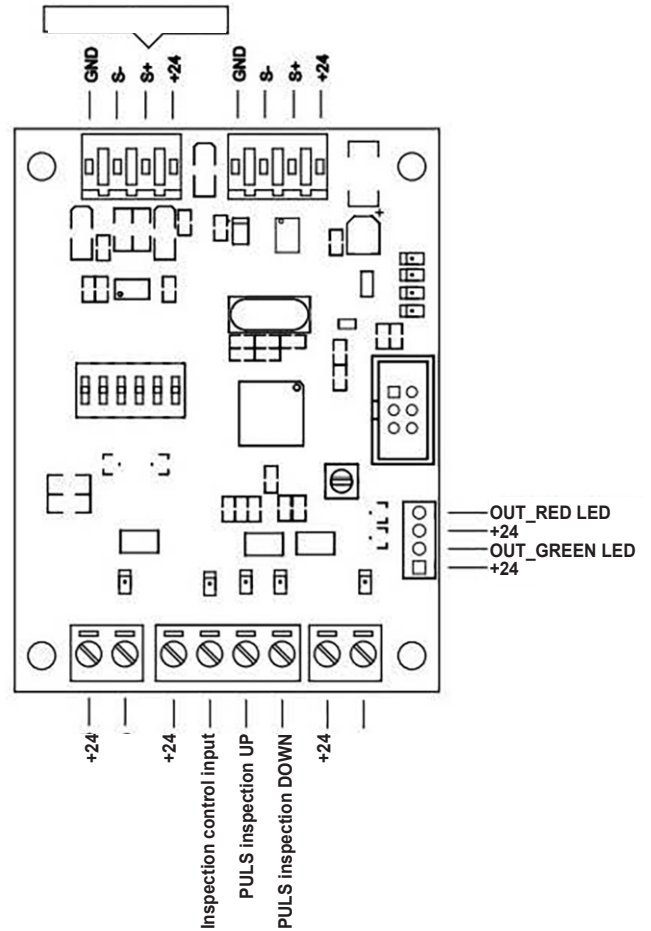

### 6.5. MP2-NR/ND BOARD LAYOUT

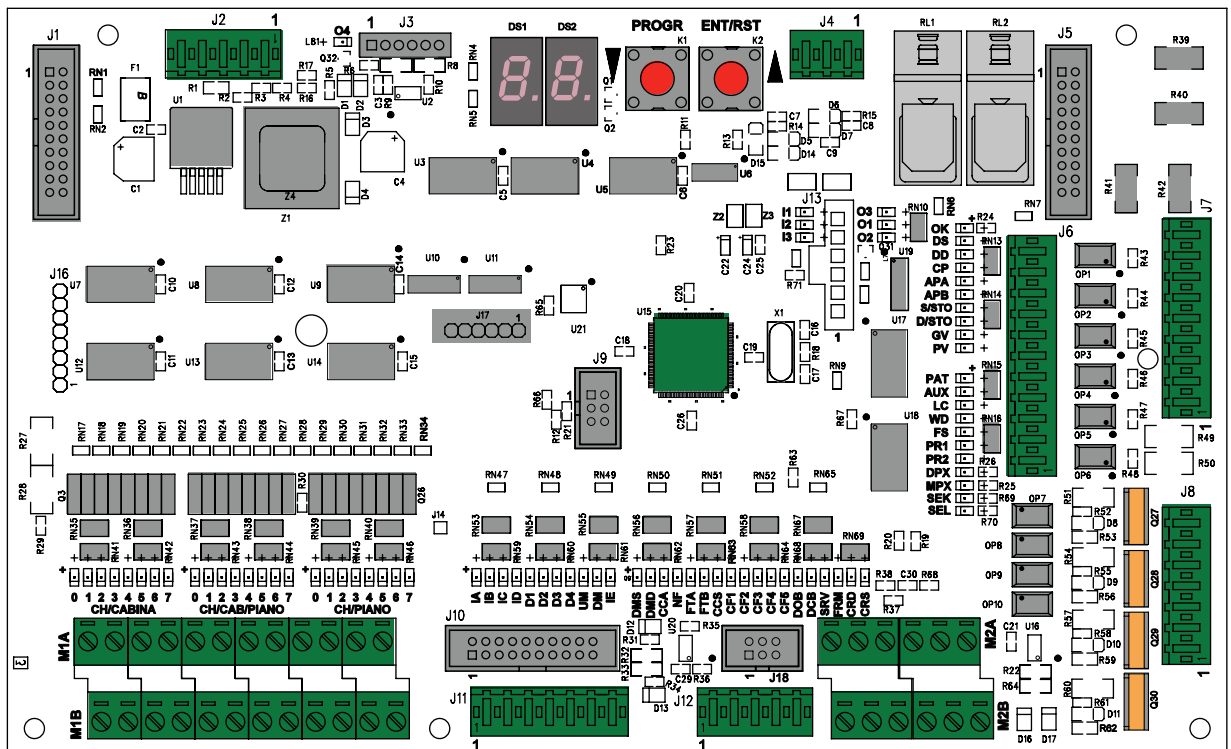



### 6.5.1. LEDs ON MP2-NR/ND BOARD

Led	Indication		Description
	output / and	Input	
OK			board/program active indication
DS	J4/4		minirelay RL1
			universal manoeuvre: floor calls common collective manoeuvre: down direction
DD	J4/1		minirelay RL2
			universal manoeuvre: occupied collective manoeuvre: up direction
CP	J6/10		door closing command
APA	J6/9		front side doors opening command
APB	J6/8		rear side doors opening command
S/STO	J8/1 > J8/2		up control signal
D/STO	J8/4 > J8/3		down control signal
GV	J8/5 > J8/6		GV command (high speed)/P connector (power) for 1 speed
PV	J8/8 > J8/7		PV control signal (low speed)/hydraulics timer with star/delta starting or 2 second stop delay
PAT	J6/7		retiring cam control signal
AUX	J6/6		travel between consecutive floors control signal
LC	J6/5		car light control signal
WD	J6/4		Manoeuvre disable/protection with hydraulics
FS	J6/3		out of service control signal
PR1	J6/2		Programmable command
PR2	J6/1		Programmable command
DPX			serial comms active indication with duplo/duplex/triplex/quadruplex manoeuvre
MPX	---	---	serial comms active indication with duplo/duplex/triplex/quadruplex manoeuvre
SEK			Communication to KM0/APP QuickUP
SEL			Communication to X_CAB Board
IA		J11/1	high speed (GV) and low speed (PV) contactor controls signal
IB		J11/2	up (S) / down (D) contactor control signal
IC		J11/3	front door movement control signal
ID		J11/4	rear door movement control signal
D1		J7/4	Safety chain 1st check
D2		J7/6	Safety chain 2nd check
D3		J7/8	Safety chain 3rd check
D4		J7/10	Safety chain 4th check
UM		M2A/2	UM reed switch: up travel
DM		M2A/3	DM reed switch: down travel
IE		J11/6	Inspection control input
DMS		J11/7	DMS reed switch: up travel minimum distance
DMD		J11/8	DMD reed switch: down travel minimum distance

Led	Indication		Description
	output/ and	Input	
CCA		M2B/1	1 passenger present in car
NF		M2B/2	80% load present in car
FTA		M2A/4	Front photocell
FTB		M2A/5	Rear photocell
CCS		J11/5	hydraulic: safety circuit variable speed drive: power contactors (TL1/TL2)
CF1		J12/4	variable speed drive and power contactors: emergency manoeuvre
CF2		J12/5	Programmable input
CF3		J12/6	Programmable input
CF4		J12/2	Programmable input
CF5		J12/3	Programmable input
DOB		M2B/3	open doors button
DCB		M2B/4	close doors button
SRV		M2B/5	reserve car manoeuvre
FRM		J12/1	fire services manoeuvre
CRD		M2B/6	Bistable phase plugs
CRS		M2A/6	Bistable phase plugs
I1		J13/6	
I2		J13/5	
I3		J13/6	
O1	J13/1		Configurable outputs
O2	J13/ 3		Configurable outputs
O3	J13/2		Configurable outputs

## 6.6. MANOEUVRES

### 6.6.1. SINGLE CALL MANOEUVRE OR COLLECTIVE DOWN MANOEUVRE

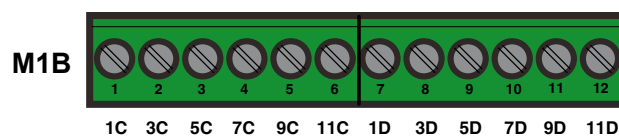
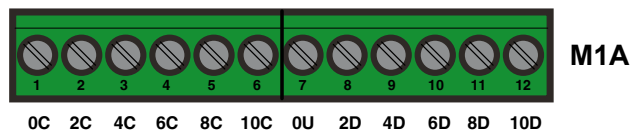

## 6.6.2. COLLECTIVE UP/DOWN MANOEUVRE

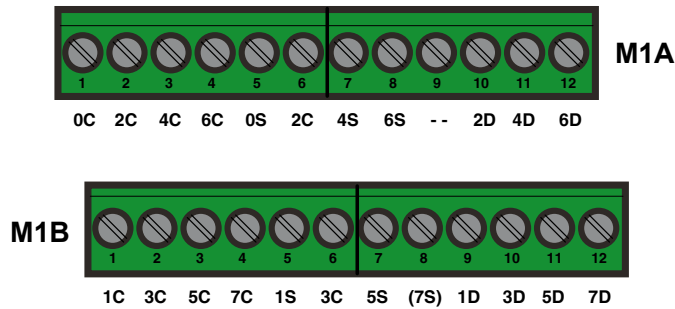

The following basic manoeuvres are provided:

- Universal
- Simplex collective down
- Simplex collective complete (up and down)
- Duplex collective down
- Duplex collective complete (up and down)
- Triplex collective down
- Triplex collective complete (up and down)
- Duplo
- Car: universal. Floors: reserve in order of call
- Car: reserve. Floors: universal
- Duplo - universal manoeuvre with interdiction of simultaneous call between two lifts
- Duplo - universal manoeuvre with interdiction of simultaneous call between two lifts and arrival of the nearest car

Different or special manoeuvres can be implemented on request.

## 6.7. CONNECTIONS FOR DUPLO/DUPLEX/TRIPLEX/QUADRUPLEX MANOEUVRES

Duplo / Duplex / Triplex / Quadruplex manoeuvre cabinets are identical to each other.

Floor calls must be connected to at least one of the cabinets.

The following connections must be made between the cabinets:

- +24D and GND terminal.
- Floor calls using the flat cable (20 pole, of which the last 4 are reserved for serial comms between the cabinets) connected between connector J10 on the MP2 boards and the flat cable (16 pole) connected between connectors J3 on the EXP expansion boards.
- To facilitate routing the flat cables in Triplex and Quadruplex systems, the TPX boards are used (installed in cabinet B for Triplex systems and cabinets B and C in Quadruplex systems).



### IMPORTANT

The tests are detailed in Par. 7 "System Tests" in the Manual for the system in question.